

GD400 Explosion Proof Portable Gas Detector User Manual



ACCURATE • RAPID • RELIABLE

PLEASE READ CAREFULLY BEFORE USING

Anyone who may use, maintain or repair the instrument should read this operating manual carefully and only follow the operating manual to achieve the design level. Otherwise the instrument will not work properly and will cause malfunction and damage to the instrument.

Warning:

- ▲ The readings beyond the range indicate the concentration of the gas that may or will soon reach the explosion concentration or the concentration of casualties.
- ▲ Replacing components can affect the intrinsic safety of the instrument.
- ▲ It is strictly forbidden to charge the meter in a hazardous area. Users must use the special charger equipped with this unit.
- ▲ Do not disassemble, recharge or replace batteries in hazardous locations. ▲ Charging must be turned off; the instrument must not be operated while charging or exporting data.
- ▲ Portable products, before entering the danger zone, doing electrostatic release of human body, and then carries the instrument into the zone.
- ▲ Do not use the computer's USB interface for communication in hazardous areas. ▲ Old and new batteries or batteries from different manufacturers cannot be mixed.

Attentions :

To ensure maximum safety and performance, please read and follow the items and conditions listed below.

- The air intake of the sensor must be kept clean. Blocking the sensor's air intake may result in readings that are lower than the actual gas concentration .
It is strictly forbidden to use compressed air to clean the air inlet of the sensor to avoid damage to the sensor.
- Catalytic Principle Flammable Gas Sensor and Infrared Principle Sensor can only accurately monitor designated gases. It should be noted, however, that the catalytic principle flammable sensor is not specific to a particular gas and will be able to react to other flammable gases.
- If the instrument is subject to physical impact or high pollution, the calibration cycle needs to be shortened.
- The sensitivity of flammable gas sensors will be affected by high concentrations of sulfides, halogen compounds, silicon-containing compounds, and gases containing "mercury" and "lead", steam, and high temperature organic acid gases. Avoid using them in environments containing the above chemicals. The instrument, if necessary, must be tested and calibrated after use to avoid affecting the accuracy of the instrument.
- The instrument is strictly prohibited from being used in a high concentration of flammable gas for a long time to avoid damage to the flammable sensor. If it is necessary, the instrument should be tested and calibrated after use to avoid affecting the accuracy of the instrument. If the flammable sensor is damaged, it needs to be replaced with a new one. The new sensor can only be reused after it has been calibrated.

- Do not use organic solvents, soap or silicon-containing solutions to clean the instrument to avoid damaging the sensor.
- When sampling with a sampling tube, do not use a sampling tube made of silicone material or other sampling tubes that are not certified by the special source.
- A sudden change in air pressure or a blocked air circuit may cause temporary fluctuations in the instrument's oxygen readings.
- Large changes in pressure will result in incorrect readings. If the measured gas pressure is greater than 10% of the atmospheric pressure, it will affect the instrument reading and even damage the sensor. The instrument should be re-calibrated and the measured gas should be depressurized.
- It is forbidden to artificially use the gas shock sensor that exceeds the range of the instrument. If the over-range high-concentration gas impact occurs, the instrument must be re-calibrated.
- When replacing any one of the sensors, the instrument needs to be calibrated.
- Standard gas should be selected from the manufacturer or the nationally qualified enterprise.
- The calibration should be in a well ventilated environment to avoid contamination.
- It is strictly forbidden to calibrate the instrument under the condition of insufficient power supply.
- Do not use the instrument in an oxygen-rich environment.
- It is strictly forbidden to replace the components or structures that affect the explosion-proof performance at will, so as not to affect the explosion-proof performance.
- It is forbidden to expose the instrument to high concentration acid and alkali gas to avoid damage to the sensor.
- It is strictly forbidden for users to repair or replace parts without authorization.
- A sudden change in temperature can cause the output signal of the infrared sensor to be abnormal. After the transient is removed, the instrument will resume normal operation and the ambient temperature change rate should be limited to 2 ° C / min.
- If the gas sample flow rate changes excessively, it will also cause the infrared sensor output signal to be abnormal. After the transients are removed, the instrument will resume normal operation and the gas flow rate should be kept below 0.6 L/min.
- It is strictly forbidden to expose the infrared sensor to corrosive gas such as hydrogen sulfide. It is strictly forbidden to cause condensation inside the sensor.
- Condensation phenomenon inside sensor is strictly prohibited.

Calibration Warning:

- Gas detection equipment is a safe life-saving measuring instrument. To ensure metering accuracy, toxic and catalytic principles flammable gas sensors should be calibrated at least once every six months, while infrared sensors should be calibrated once a year.

- The gas detector needs to be carefully tested or calibrated after an alarm occurs.

- This instrument has the function of recording and querying the calibration date. Please check it frequently. Not only do users need to understand the parameters of the instrument, but they also need to understand the meaning of the test data obtained.

Contents

1, Overview	7
2, Product series and models	7
3, Product characteristic	7
4, Product description	7
5, Product configuration	8
6, Technical specifications	8
7, Battery charge	9
8, Operation procedures	10
9, Power on/off	11
9.1 Power on	11
9.2 Power off	12
10, User interface	13
10.1 Detection interface	13
10.2 Status Indicator/Icon	13
11, Operation overview	14
11.1 Alarm function checking	14
11.2 Information checking	14
11.3 Menu	15
12, Function	15
12.1 Fresh air/zero calibration	15
12.2 Span calibration	16
12.3 Calibration interval	18
13, Alarm setting	18
13.1 Alarm limit	18
13.2 Alarm mode	19
13.3 Alarm latched	20
13.4 Man down alarm	21
13.4.1 Turn on/off man down alarm	21
13.4.2 Motion less Time	21
13.4.3 Sensitivity	21
13.4.4 Warning time	21
13.5 Comfort beep	22
13.5.1 On/off	22
13.5.2 Time	22
14, Datalog	22
14.1 Storage on/off	22
14.2 Storage interval	23
14.3 Data type	23
14.4 Data view	23
14.5 Data disk	24
14.6 Full option	25
14.7 Clear record	25
15, Monitor set	25
15.1 Pump on/off	25
15.2 Unit	26
15.3 Date and time set	26

15.4 Language	26
15.5 Display set	26
15.5.1 Brightness	26
15.5.2 Auto brightness	27
15.5.3 Screen rotation	27
15.5.4 Sleep mode set	27
15.6 Security and Privacy	28
15.6.1 Modify Password	28
15.6.2 Site ID and User ID	28
15.7 Self-test	28
15.8 Reset	29
15.8.1 Reset Sensor	29
15.8.2 Reset device	29
15.9 Bluetooth	29
16, About	30
16.1 Monitor Information	30
16.2 Sensor information	30
16.3 Calibration record	30
17, Common faults and solutions	31
18, Terms of Service	32
18.1 Warranty Commitment	32
18.2 Fault repair time	32
18.3 Limited liability guarantee	32
19, Technical support and manufacturer	33

1、 Overview

GD400(volatile organic compounds , combustible gas and toxic gas) at the same time and has man down alarm function. The device has humanized operation functions such as one-key security detection, one-key storage, automatic image flipping, as well as the man down alarm function. With optional Bluetooth transmission function, allowing safety personnel to obtain real-time data and the alarm status, it has obtained international IECEx, ATEX explosion-proof certification and Chinese explosion-proof certification; As it passed the antistatic test, and the protection level reaches IP67; With safer product design and the module design which makes the detection faster, and the compact ergonomic design makes the device easy carrying.

The explosion-proof grade of the GD400 series is Ex d ia IIC T4 Ga, which is applicable to the explosive gas mixture zone 0, zone 1, and zone 2 of the factory with grades IIA, IIB, and ITC and temperature group T1~T4.

2、 Product series and models The

SKY3000 series includes:

1. GD400(regular 4-in-1)
2. GD400-M (single gas)
3. GD400-M2 (two composite gases)
3. GD400-M3 {three composite gases)
4. GD400-M4 (unconventional 4-in-1 gas)

3、 Product characteristic

Rugged and durable

The instrument can effectively resist a three-meter drop.

The protection level of the instrument reaches IP67.

The instrument has passed the EMC anti-static interference test and can work normally in the walkie-talkie environment.

Explosion-proof circuit design, safe and reliable

The instrument has got IECEx, ATEX, Chinese explosion-proof certificates and the explosion-proof level reaches Ex d ia IIC T4 Ga

Multiple security protection

The man down alarm function has upgraded the safety of underground operators. Password protection function prevents non-operators from modifying menu parameters. With safety reminder function, sound and light vibration alarm function, let operators work without worries.

The high and low alarm latched function allows the operator to better capture the sudden change of the gas concentration value.

Simultaneous measurement of multiple gases, multiple numerical display The instrument can detect 1-5 gases at the same time.

Real-time value, TWA, STEL, MAX, MIN multiple numerical display.

Large screen display, flexible detection system, multiple filtering devices

The screen can be automatically turned 180 degrees, which is convenient for viewing in special operating environments.

Built-in powerful sampling pump, fast detection speed.

Can be connected 20m sampling tube externally, which is convenient for long-distance or

confined space detection.

With a water trap filter, it can effectively filter water, oil, dust and other impurities. It can also be used in harsh industrial environments , such as coal mines and petroleum fields.

Powerful function, more user-friendly operation

Beautiful and friendly user interface, reasonable and easy-to-use interactive mode. Optional Bluetooth function, data can be transmitted to the mobile phone or PC in real time.

Standard storage function, one-click data export, convenient for users to analyze.

Unique modifiable ID identification function, convenient for users to allocate and manage the instrument.

A full range of automatic detection functions, automatic prompts for voltage, pump failure alarms, etc. more comfortable to use One-key security detection, one-key open storage, automatic image flip.

Support PPM and mg/m3 gas unit switch, the concentration value is automatically converted by the system.

Support each channel sensor to restore the factory setting separately. Support multi-Language including English , Chinese and etc.

4、 Product description

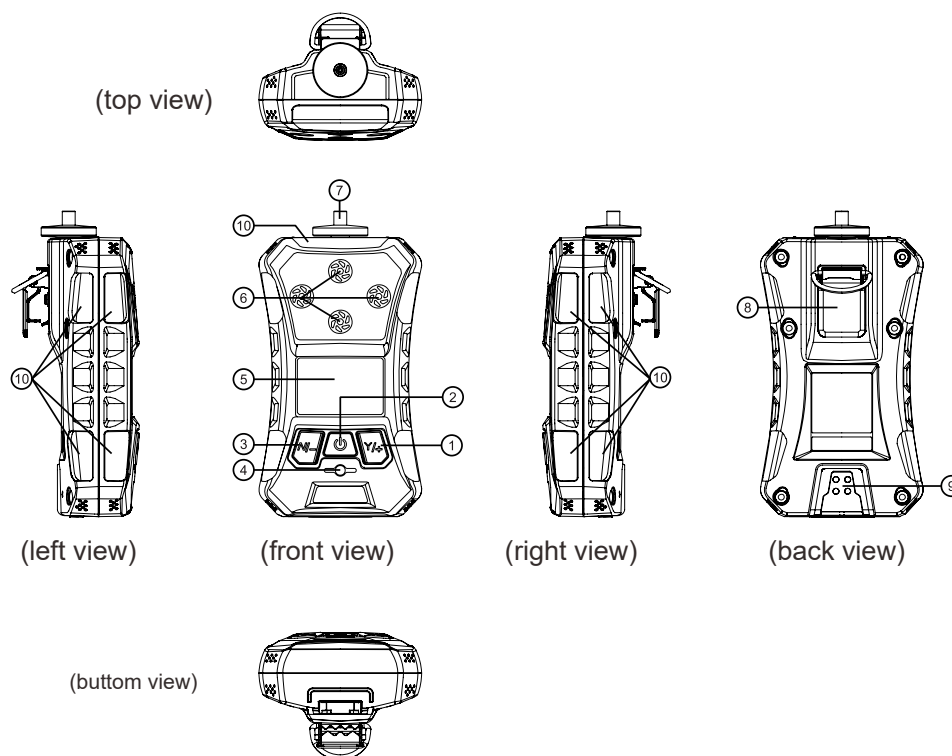

①	Y+key	⑥	Gas outlet
②	Mode key	⑦	Gas inlet
③	N-key	⑧	Belt clip
④	Buzzer	⑨	Charging and communication contact
⑤	Display	⑩	Alarm light



- ① [Y/+] key, Long press to turn on or off the datalog function (main interface); confirm entry/switch (menu interface); Numerical increase (need to enter the numerical interface); stop (calibration countdown interface).
- ② [MODE] key, Long press to power On/off (any interface): Exit (menu interface) Confirm (need to enter the numerical interface).
- ③ [N/-] key, Long press to enter the main menu (the display interface enters the menu interface); move down or right options (menu interface).
- ④ Buzzer: Voice prompt and alarm function.
- ⑤ Display, Display gas concentration and various parameters.
- ⑥ Sensor, Measure gas concentration.
- ⑦ Filter, Gas inlet.
- ⑧ Belt clip, Stainless steel material, auxiliary fixing entrainment instrument.
- ⑨ Charging and communication contact: Connect the charging stand to charge the instrument / transmit data to the PC.
- ⑩ LED light, Light alarm function.

5、 Product configuration

- 1, Standard accessories :
 - (1) Gas detector 1 piece
 - (2) 12V/1A DC power adapter 1 piece
 - (3) Charge base 1 piece
 - (4) USB cable 1 piece
 - (5) User manual 1 piece
 - (6) warranty card 1 piece
 - (7) Filter 1 piece
 - (8) Aluminum suitcase 1 Piece
 - (9)1 rubber stopper (please install the rubber stopper in time after charging/data transfer is completed.)

6、 Product specifications

Sampling method	pump suction type
Response time	CO、 O2、 EX<30 seconds, H2S<60 seconds
Language	Chinese/English (more language can be customized)
Automatically test and calibrate after power-on	Including reset,maximum value (MAX), minimum value (MIN), STEL, TWA value
Unit	μmol/mol、 mg/m ³ 、 PPM can be swiftd

Display	monochrome graphics (160x96) ,screen can be automatically flipped
Backlight	The backlight time can be manually set, and will be turned on automatically when an alarm is issued
Data record	Can store 100,000 sets data, the storage interval is adjustable from 5 to 3600 seconds, data can be exported, with data cable
Alarm	95dB buzzer (@30cm), vibration alarm and flashing red LED and alarm status indication on the screen, alarm latched; diagnostic alarm and battery undervoltage alarm, pump block alarm; man down alarm, with early warning and optional real-time remote Bluetooth
Battery	3.7V rechargeable lithium battery
Working hours	More than 15 hours in continuous pumping mode
Charger	Travel charger with DC interface, charging time = 4 hours
Explosion-proof grade	IECEx:Ex da ia IIC T4 Ga(with EX sensor),Ex ia IIC T4 Ga(without EX sensor) ATEX:  II 1G Ex da ia IIC T4 Ga,  II 1G Ex ia IIC T4 Ga
Certification (EU Regulation)	2014/34/EU(ATEX)
Protection grade	IP67
Working temperature	-20°C~+50°C
Humidity	0~90%RH (no condensation)
Environmental pressure	86~106Kpa
Size	157*84.5*59.5mm (including back clip/water trap filter) (length• width • height)
Weight	365g(including battery, belt clip and filter)

7、 Battery charging

The detector is equipped with special charging equipment, and the charging process is shown in the figure below.

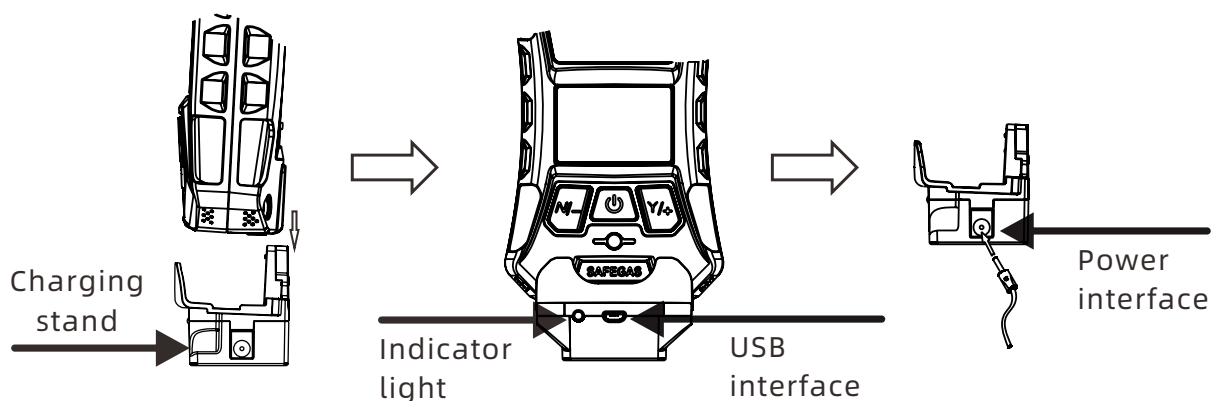

- 1、 First, insert the charging/ communication contact into the charging stand to ensure that the detector is tightly engaged with the charger stand
- 2、 Then insert the round plug of the power adapter into the jack on one side of the charger stand, and plug the other end of the power adapter into the power source.
- 3、 The detector is charged after connecting with power source, the LED indicator is red, and the display shows the charging status. After the battery is fully charged, the display shows that the battery is fully charged which means the charging is complete.

Note

1. It is forbidden to charge the detector in non-safe areas.
2. Please do not violently plug or unplug the detector and charging equipment.
3. Before charging, check whether there is dirt on the contacts and probes, whether the contacts on the back of the detector are in good contact with the probes of the charging stand, and whether the bite is in place.

8、 Operation process

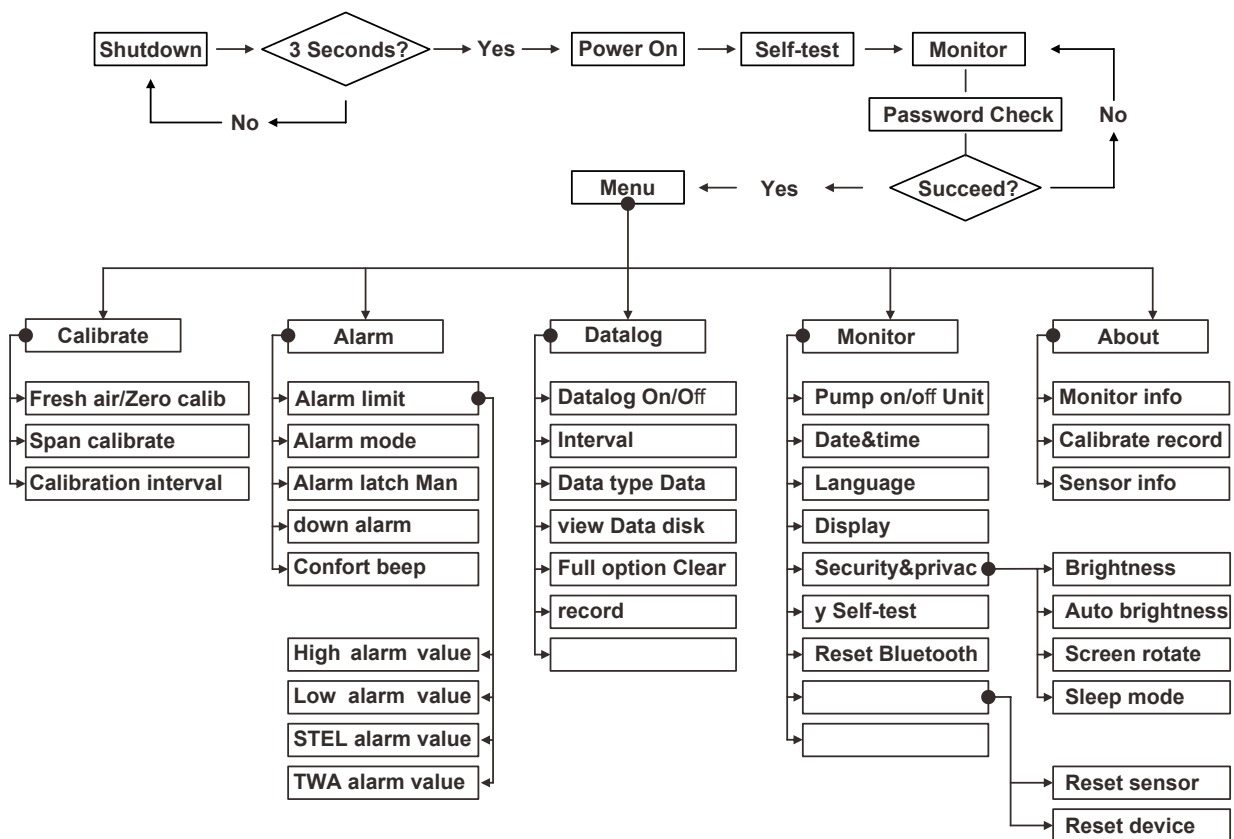

9、 Power on/off

9.1 Power on

When the detector is off, press and hold the [MODE] key, the backlight will light up, and a countdown progress bar will appear on the screen. Release the [MODE] key after the countdown complete. Then the detector starts, the backlight, alarm light and vibration turn on. SAFEGAS mark will appear on the screen, and then enter the self-check interface.

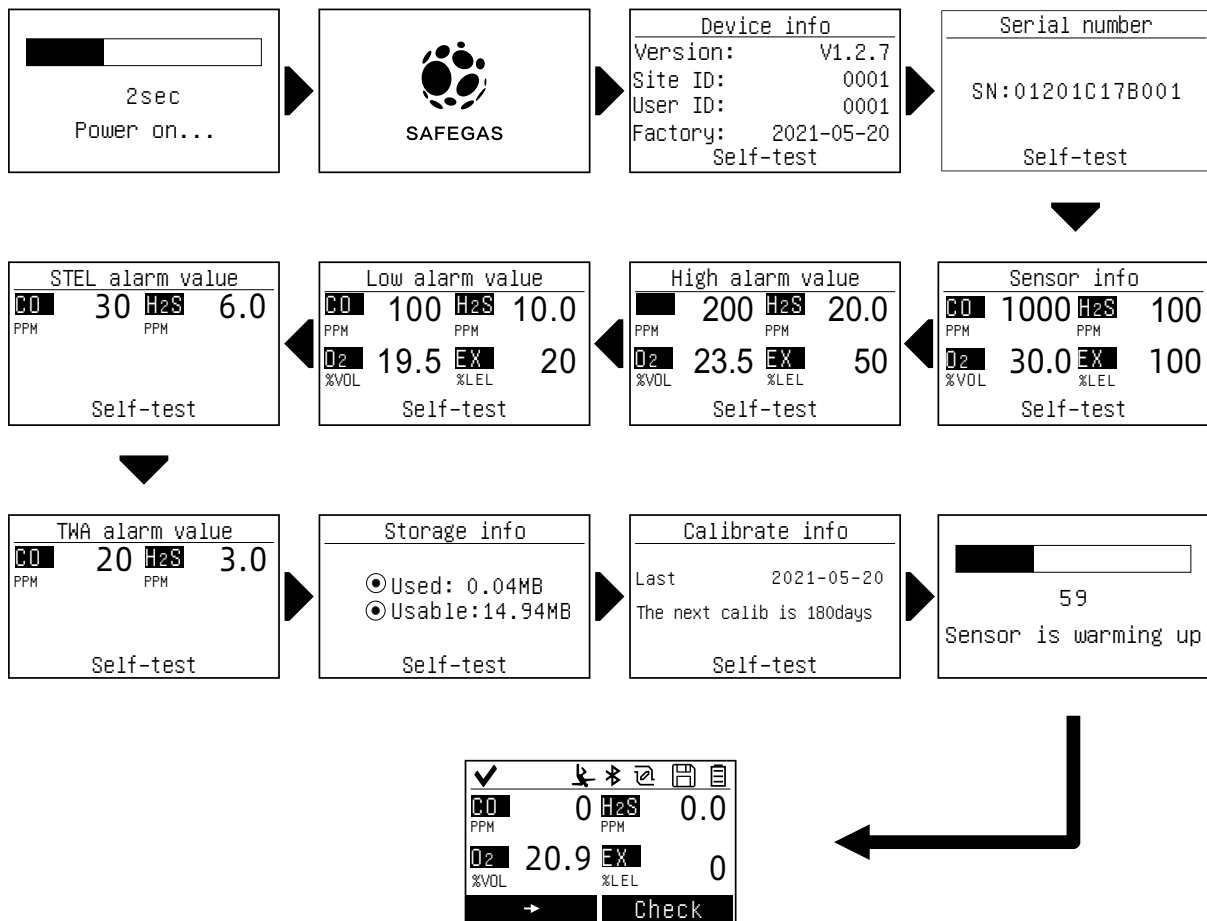

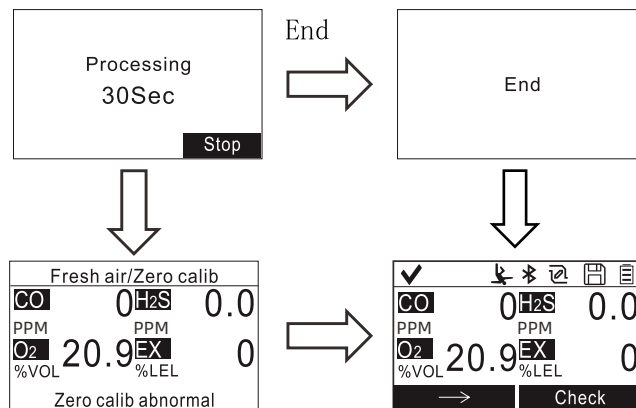

The normal start up of the detector will gradually display the following steps, showing the current settings of the instrument:

1. Equipment information: version, site ID, user ID, manufacture date
2. Serial no
3. Sensor information
4. High alarm value
5. Low alarm value
6. STEL
7. TWA
8. Data log information
9. Calibration information

After loading the self-test interface, it will enter the sensor preheating interface, and there will also be a countdown action. This action takes about 1-2 minutes. After the countdown, the display interface will prompt whether the detector is performing fresh air/zero calibration.

During the calibration, a 10-second countdown will be displayed, and the calibration can also be terminated during the process. Once the calibration is completed, it will formally enter the detection interface and the detector is successfully turned on.

Note: Please keep the battery fully charged and start the machine in a fresh air environment. If you can't start the machine to eliminate the above problems, please contact sales for consultation.

9.2 Power Off

Press and hold [MODE] . A 5-second countdown to shutoff begins. You must hold your finger on the key for the entire shutoff process until the device is powered off.

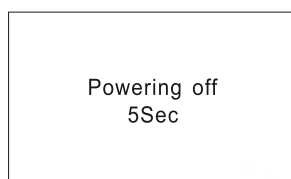

Device info	
Gas	CO/H2S/O2/EX
Range	1000/100/30/100
Power	100%
Site ID	0001
User ID	0001

In the Shutdown state, long press [N/-] key for 3 seconds to briefly display the following

device information

1. Gas type
2. Measure range
3. Power
4. User ID
5. Site ID

Note: Please turn off the device after the reading drops to zero in clean air (except for oxygen, nitrogen and carbon dioxide)





10、 User Interface

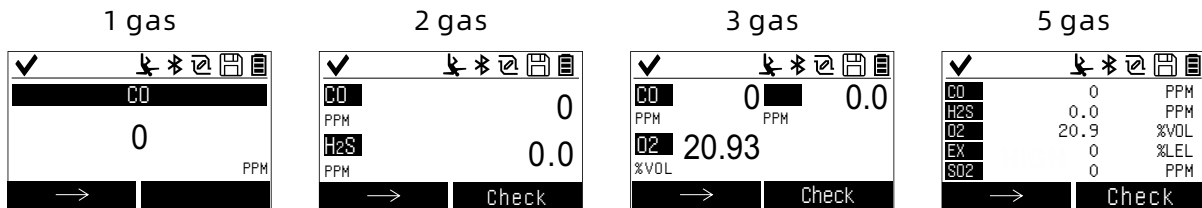
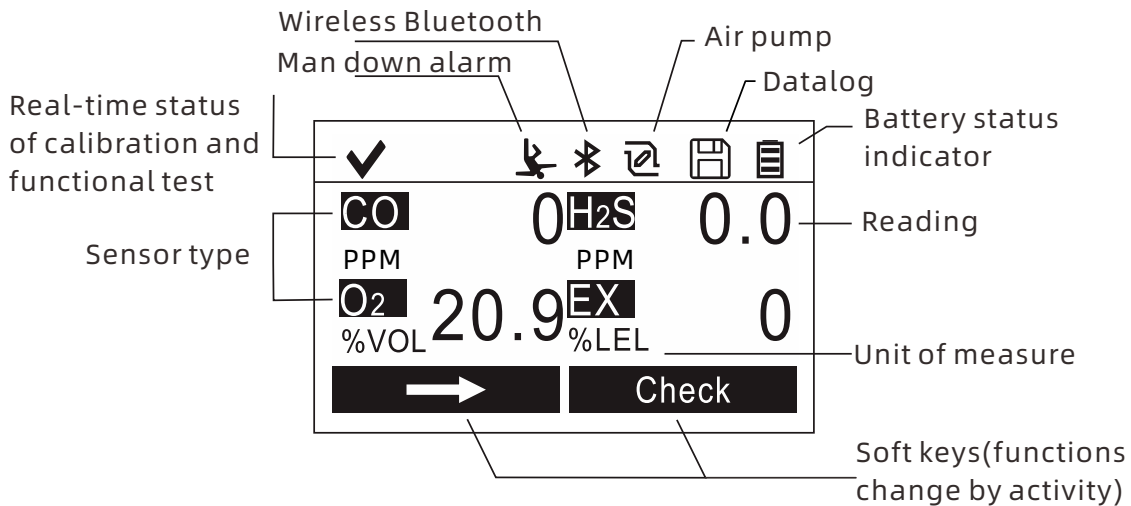

10.1 Detection interface

The LCD display provides visual feedback that includes the sensor types, readings, battery condition, and other functions.



10.2 Status Indicator Icon

Icon	function
	Bluetooth function(This is an optional function, shown when bluetooth is on,blank when off) Pump
	on status
	Pump off status
	Storage function (Shown when storage is on, blank when off)
	Power (three segments show battery charge level)

	Man down alarm function (Show when man down alarm is on, blank when off)
	Self-test passed
	Self-test failed

11、 Operation overview

11.1 Alarm function checking

On detection interface, press [Y/+] key to test whether the buzzer, vibration alarm, LED indicator and backlight function are in good condition. The following interface shows when the buzzer is off.

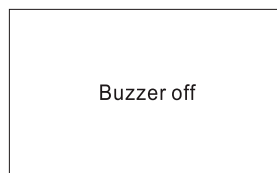

Note: The premise for the one-key check function to take effect is in normal mode and non-alarm state.

11.2 Information checking

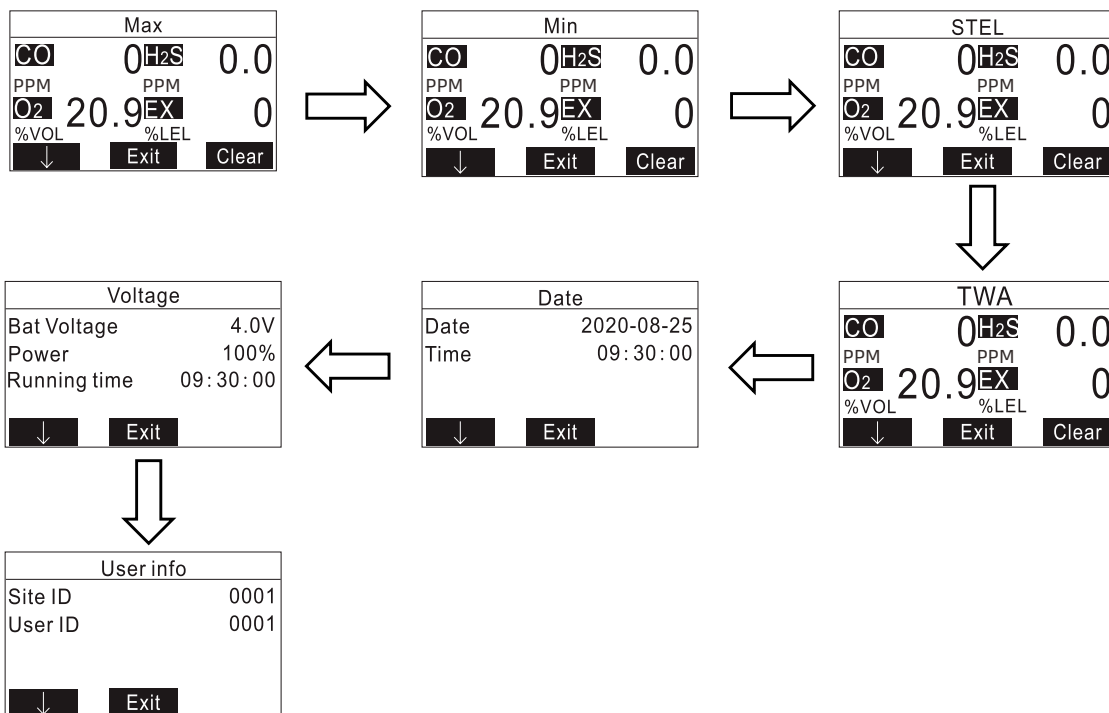

On detection interface, press the [N/-] key to display the following interfaces in sequence.

1. Max value
2. Min value
3. STEL value
4. TWA value
5. Date and time
6. Batter voltage, power, running time
7. User information: Site ID,user ID

When the device is in the above information interface, press the [MODE] key can back to the detection interface, press the [Y/+] key to clear. After all the information interfaces are displayed, press the [N/-] key to return to the detection interface.

11.3 Menu

To enter main menu interface, press and hold [N/-] key for 3 seconds until you see the Password screen.

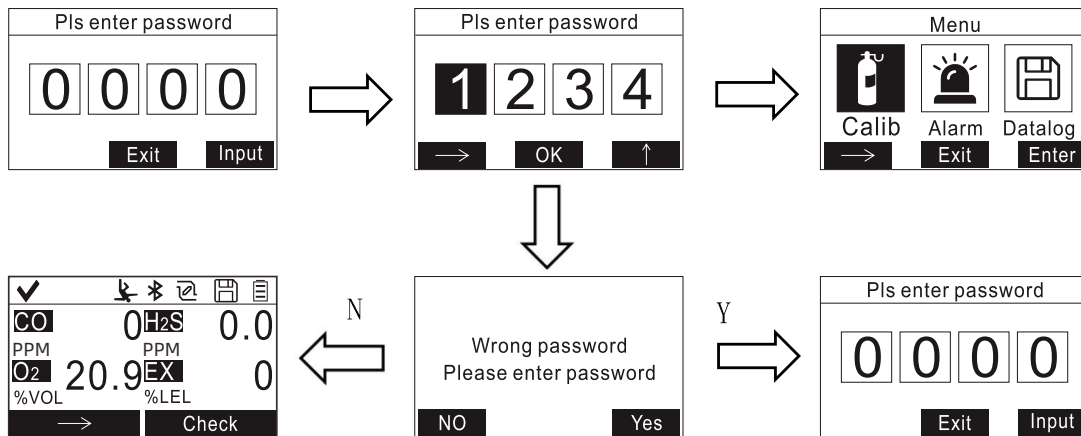

Input the 4-digit: password

- Increase the number from 0 through 9 by pressing [Y/+].
- Step from digit to digit by using [N/-] .
- Press [MODE] when you are done.
- If you make a mistake, you can cycle through the digits by pressing [N/-] and then using [Y/+] to change the number in each position.
- If you input the correct password, you will enter the main menu. If you input the wrong password, you will enter the mistake prompt interface. Press [N/-] key and select No to back to display interface. Press [Y/+] key to back to password screen.

Note: The default password is 1234. The password screen only appears when you enter the main menu at the first time. If you have input the correct password, you do not have to input it again to enter main menu until you turn the device off and on again.

12、 Functions

12.1 Fresh Air/ Zero Calibration

At the Calibration menu, press [N/-] key to select the sensor and then start the calibration by pressing [Y/+], then there is a 30 seconds of countdown, the device will send a buzzer sound. The calibration is done when the screen shows you a Succeed.

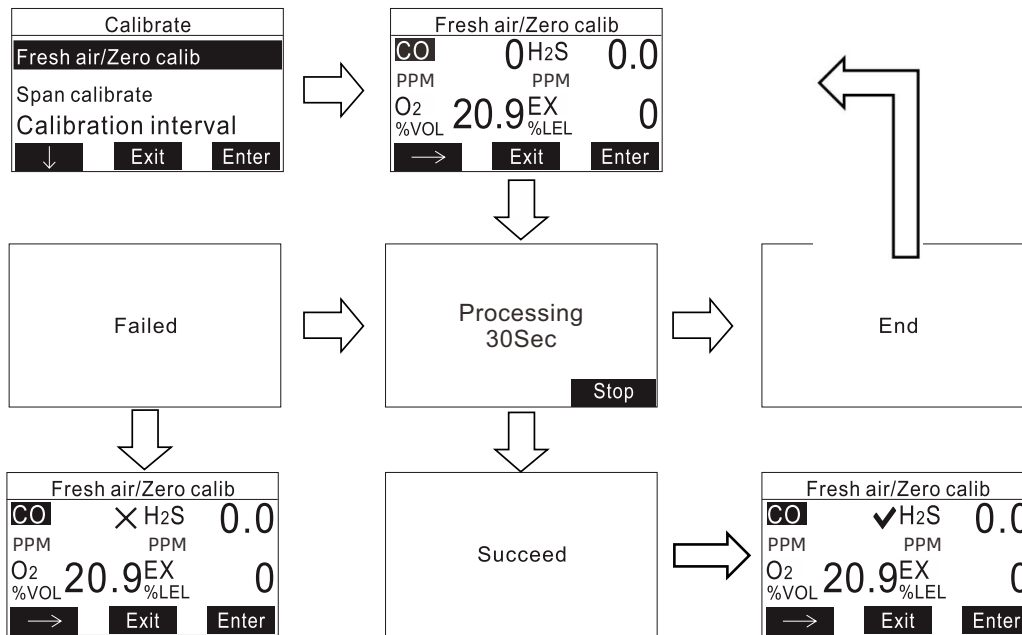

You can terminate the calibration at any time during the countdown by pressing [Y/+]. If the calibration is succeed, it will show av beside the calibrated gas, if the calibration is failed, it will show √ beside the calibrated gas.

- Note: 1. Sensor should be calibrated in the dry air with 20.9% of oxygen and no impurities.
2. The zero point calibration should be done before the span calibration.

12.2 Span Calibration

GD400 draws in air at a flow rate of between 450mL/min -650mL/min. When calibration, the device must be connected to a standard gas cylinder through a T-shaped calibration tube (three-way connector), and the other end is connected to a flow meter. During ventilation calibration, ensure that the evacuation of the flow meter is above 100mL/min.

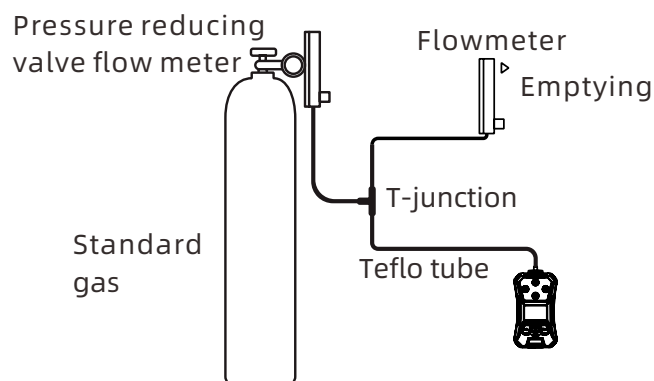

- Press [N/-] to select the gas, then press [Y/+] to enter selected gas calibration screen.

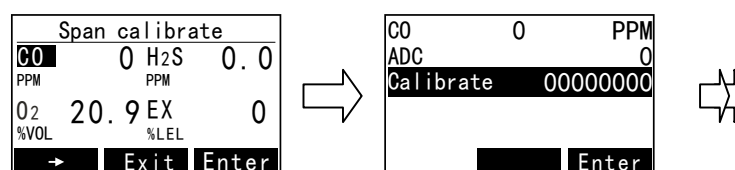

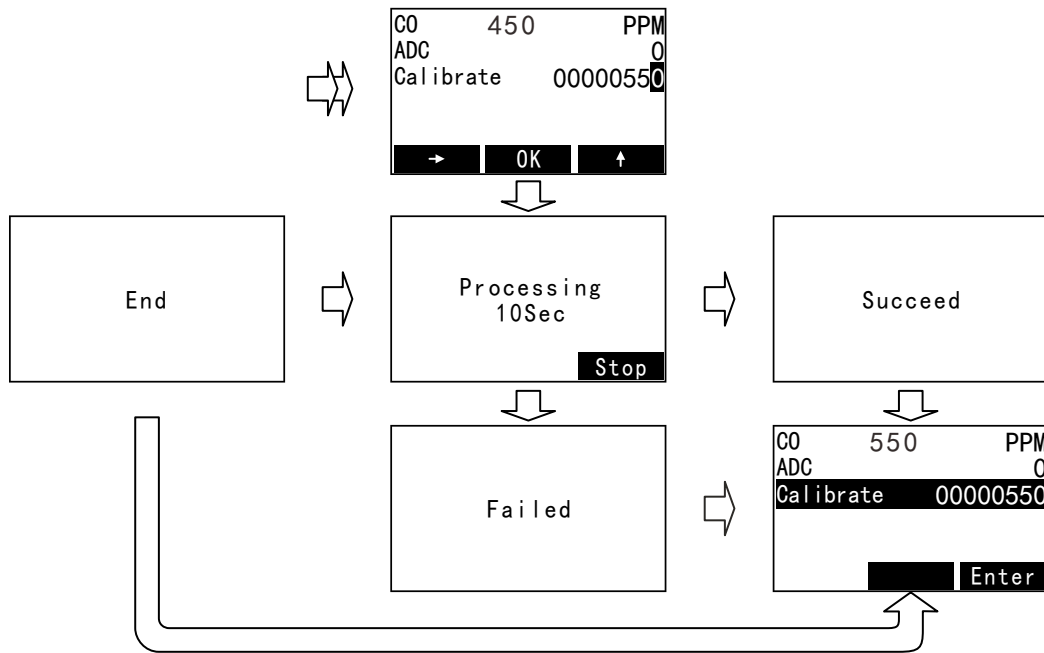

There is a calibrate in the span calibration sub-interface, and the right side is the calibration setting value. The upper part displays the current gas type, real-time concentration value, unit and ADC value.

The span calibration procedure is as follows (the following example assumes a standard gas of 550 ppm CO):

- After the detector is turned on and enters the detection interface, connect the standard gas of known concentration to the gas inlet of the detector through the PTFE tube.
- Enter the span calibration interface, press the [N/-] key to select the gas channel, and press the [Y/+] key to enter the “span Calibration ” submenu.
- Press - the [Y/+] key to enter the parameter setting mode, and modify the value (set value 550) on the right to the standard gas concentration used.
- Open the standard gas valve, and input the target CO standard gas to the detector at a flow rate of 500mL/min (ml/min), until the real-time concentration displayed by the detector (the upper middle) is basically stable (about 1-3 minutes, different sensors the stabilization time is different), press the button, the detector will enter the 30-second countdown, after the countdown, the detector will have a buzzer sound, and the screen will show succeed to tell you the span calibration is completed.

Note :

1. During the calibration countdown period, you can press the [Y /+] key to terminate the span calibration.
2. Before the span calibration, please confirm that the standard gas tube has been well connected. Only starts the span calibration after the displayed value is stable, otherwise the reading will be inaccurate.
3. Setting value: input the concentration of the standard gas.
4. When selecting the calibration point, please follow the principle of zero point value < calibration value < full range value, otherwise calibration will fail.

12.3 Calibration interval

It is used to remind the user that the device needs to be re-calibrated. The factory default calibration interval is 180 days (the setting range is 0-360 days). If the calibration expires, it will remind the user that the device needs to be re-calibrated when you power on.

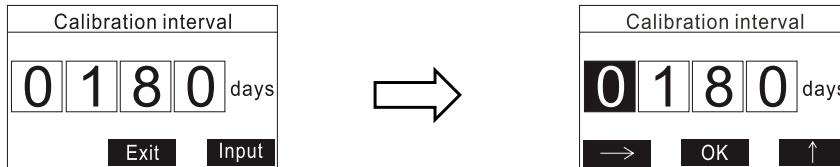

Calibration interval setting,

- Press [Y/+] to change the number.
- Press [N/-] to move digit.
- Press [MODE] to complete.

13、 Alarm setting

13 .1 Alarm limit

There are 4 alarm settings for every type of gas as following:

- High alarm value (High alarm point)
- Low alarm value (Low alarm point)
- STEL value (Short-term exposure limit)
- TWA value (Weighted average)

Take setting the high alarm limit as an example, press the [Y/+] key on the alarm limit setting interface to enter the high alarm limit interface.

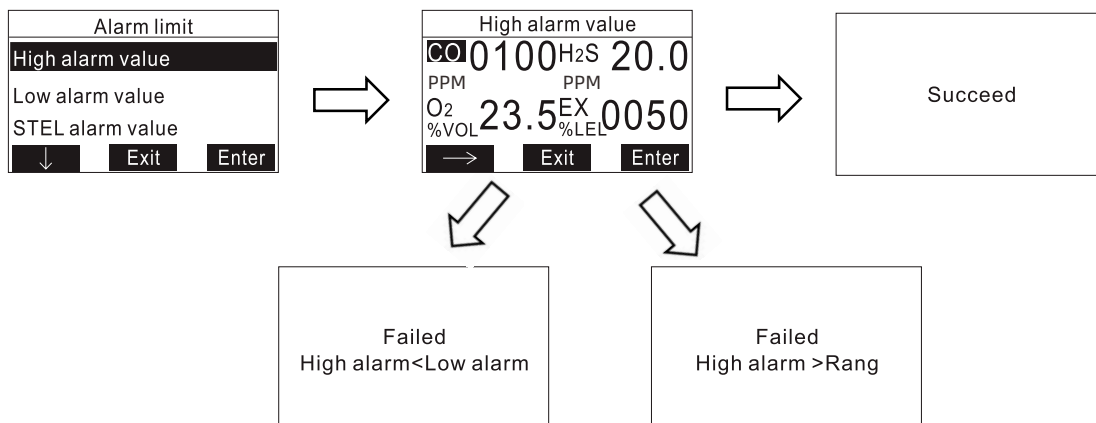

High alarm limit setting,

- Press [Y/+] to change the number.
- Press [N/-] to move digit.
- Press [MODE] to complete.

Evaluation using the short-term exposure tolerable concentration (PC-STEL) standard

The test result is the 15min time-weighted average concentration of hazardous substances measured at the highest concentration of hazardous substances at the operation site. The calculation method of the 15min time-weighted average

concentration is:

(1) When the sampling time is 15min, the time-weighted average concentration of 15min is the test result of the sample, mg/m³.

(2) When the sampling time is less than 15min, when sampling more than once, calculate as follows: $C_{STEL} = (C_1T_1 + C_2T_2 + \dots + C_nT_n) / 15$

In the formula: C_{STEL} - 15min time-weighted average concentration, mg/m³;

C_1, C_2, C_n - measured concentration of harmful substances in the air, mg/m³;

T_1, T_2, T_n - the working time of workers at the corresponding concentration of harmful substances, min.

The time-weighted average allowable concentration (PC-TWA) standard was used to evaluate

The test result is the 8-hour time-weighted average concentration of occupational disease hazard factors in the workplace. The 8-hour time-weighted average concentration is calculated as follows: $C_{TWA} = (C_1T_1 + C_2T_2 + \dots + C_nT_n) / 8$

In the formula: C_{TWA} - 8h time-weighted average concentration of harmful substances in the air, mg/m³;

C_1, C_2, C_n - measured concentration of harmful substances in the air, mg/m³;

T_1, T_2, T_n - the working time of workers under the corresponding concentration of harmful substances, hour

Use the maximum overrun multiple to evaluate

Many substances with PC-TWA have not yet formulated PC-STEL. For dust and chemicals without PC-STEL, the upper drift limit should be controlled even if their 8h TWA does not exceed PC-TWA. Therefore, the over-limit multiple can be used to control the excessive fluctuation of its short-time exposure level. The concentration corresponding to the exceeding multiple is the short-term exposure concentration, and the sampling and detection methods are the same as those of PC-STEL. For chemically harmful factors for which PC-STEL is not formulated, the concentration of any short-term (15min) exposure should not exceed the multiple of PC-TWA under the condition of the 8h time-weighted average allowable concentration.

Calculation of overrun multiples: $\text{Overrun multiple} = C_{15min} / \text{PC-TWA}$

In the formula: C_{15min} —measured short-term harmful substance concentration in the air, mg/m³; PC-TWA—The time-weighted average allowable concentration of the hazardous substance.

Note:

1. The low alarm value can't be higher than the high alarm value.
2. The low alarm value or high alarm value can't be higher than measure range.
3. There is no STEL value and TWA value for oxygen and combustible gas.

13.2 Alarm mode

There are three alarm modes including LED light, buzzer, and vibrator. The user can switch on or off the three mode by pressing the [Y/+].

Note: The three alarm modes of the device are turned on by default. Do not turn off them unless necessary.

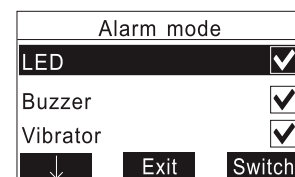

Alarm Signal Summary

Type	State			
	LED	Buzzer	Motor	Disable all
Key tone	noting	Sing 50ms/times	noting	-
Check	On 50ms,off 50ms,5 times	Sing 500ms,stop 500ms, 1 times	On 500ms,off 500ms, 1 times	noting
Low alarm	On 250ms,off 250ms,2 times	Sing 250ms,stop 2500ms, 3 times	On 500ms,off 500ms, 1 times	noting
High alarm	On 130ms,off 120ms,4 times	Sing 130ms,stop 120ms, 4 times	On 500ms,off 500ms, 1 times	noting
Warning alarm	On 100ms,off 100ms,5 times	Sing 100ms,stop 100ms, 5 times	noting	-
Man down alarm	On 50ms,off 50ms,10 times	Sing 50ms,stop 50ms, 10 times	noting	-
Low power alarm	noting	Sing 200ms,stop 200ms, 7 times	noting	-

13.3 Alarm latched

There are four mode in Alarm latched

Automatic reset: when the device is restored from the high/low alarm state to the normal state, the device will automatically release the alarm.

Low alarm latched: When the device is restored from the low alarm state to the normal state, it still locks the previous low alarm state, and the alarm lock box pops up every 20 seconds until the alarm is manually released or the automatic reset or high alarm latched option is reset.

High alarm latched: when the devices restored from the high alarm state to the normal state, it still locks the previous high alarm state, and the alarm lock box pops up every 20 seconds until the alarm is manually released or the automatic reset or high alarm latched options reset.

High&Low latched: when the device is restored from the high/low alarm state to the normal state, it still locks the previous high/low alarm state, and the alarm lock box pops up every 20 seconds until the alarm is manually released or the automatic reset, high alarm latched or low alarm latched are reset.

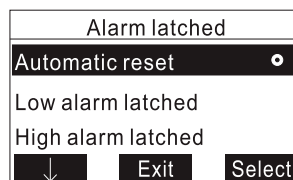

- Press [N/-] to select the alarm mode and press [Y/+] to confirm.

13.4 Mandown alarm

13.4.1 Turn on or off man down alarm

When man down alarm function is turned on, its icon will show on display interface:

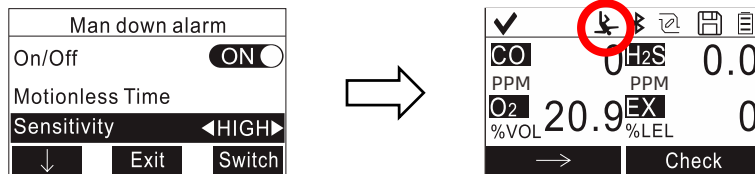

- Press [Y/+] to turn on or off man down alarm.

13.4.2 Motionless Time

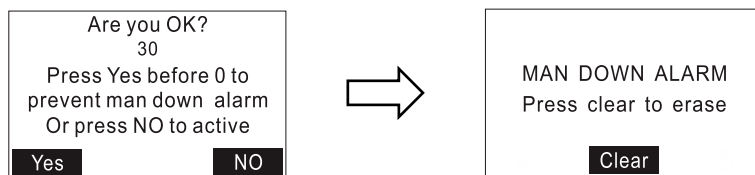

When the Man Down alarm is activated, the device detects that the motionless time exceeds what was set before, if the device still keeps stand, it will send the buzzer sounds at the same time a pre-alarm is activated to alert the user and shows the "Are You OK?" screen. Pressing [N/-] clears the alarm and returns to its normal operation. Press [MODE] to clear man down alarm info.

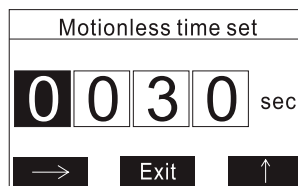

The motionless time can set by user (Range: 30-360 seconds)

- Press [Y/+] to change the number.
- Press [N/-] to move digit.
- Press [MODE] to complete.

13.4.3 Sensitivity

The sensitivity of the man down alarm function refers to the sensitivity of the three-axis sensor. The higher the sensitivity, the smaller the tilt angle of the three-axis sensor, and the less likely it is to activate the man down alarm function. The lower the sensitivity, the easier it is to activate the man down alarm function.

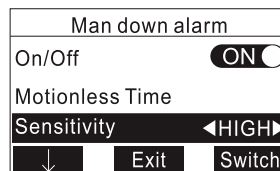

- Press [Y/+] to adjust the sensitivity.

13.4.3 Warning time

The countdown time of the pre-excitation prompt interface can be set (Range: 30-360 seconds).



- Press [Y/+] to change the number.
- Press [N/-] to move digit.
- Press [MODE] to complete.

13.5 Comfort beep

13.5.1 On/Off

Comfort beep is to make a long beep every specified time, reminding the user to be safe. It can be turned on or off.

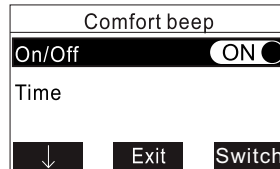

- Press [Y/+] to turn on or off the comfort beep.

13.5.2 Time

The time interval of comfort beep can be set.



- Press [Y/+] to change the number.
- Press [N/-] to move digit.
- Press [MODE] to complete.

Note: Comfort beep will tweet when the following conditions are met:

1. The comfort beep function is turned on.
2. The device is in the gas detection interface.
3. The device is not in battery alarm state.
4. The device is not in alarm state.

14、Datalog

14.1 Storage On/Off

When the storage function is turned on, there is a storage icon displayed in the upper right corner of the detection interface.

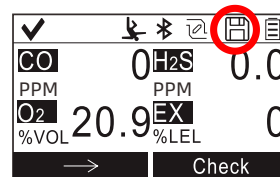
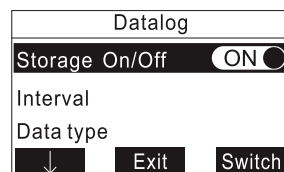

- Press [Y/+] key to turn on or off the data log function.

14.2 Storage interval set

The user can set the storage time interval value, the minimum time interval is 5S.

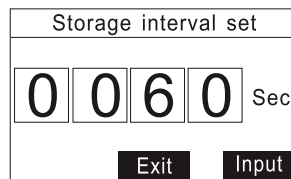

- First press the [Y/+] key to confirm the input, and then continue to press the [Y/+] key to modify the value.
- Press [N/-] to move the cursor.
- After entering the number of seconds, press [MODE] to save and exit.

14.3 Data type

The data types stored by the instrument include real-time data, maximum value, minimum high alarm value, low alarm value and all alarm values. The user can freely choose one of the value, stored data types.

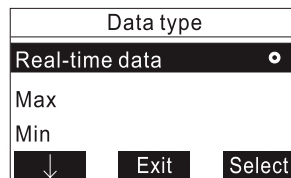

- Press [N/-] to move the cursor, press [Y/+] to select and confirm.

14.4 Data View

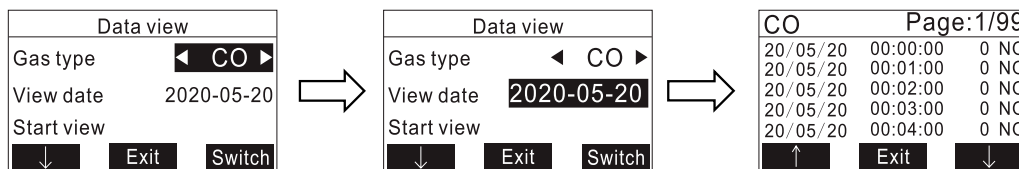

The user can view the corresponding time point and data records of different types of sensors on the instrument through the storage view function.

The specific operations are as follows:

- First press the [Y/+] key to switch the type of gas to be viewed
- Then press the [N/-] key to switch to the date viewing option, and press the [Y/+] key to confirm
- Continue to press [N/-] and [Y/+] to adjust the date
- Finally press the [N/-] key to switch to the start view, press the [MODE] key to confirm the view.

14.5 Data Disk

The user can copy the stored data of the instrument to the computer through this function.

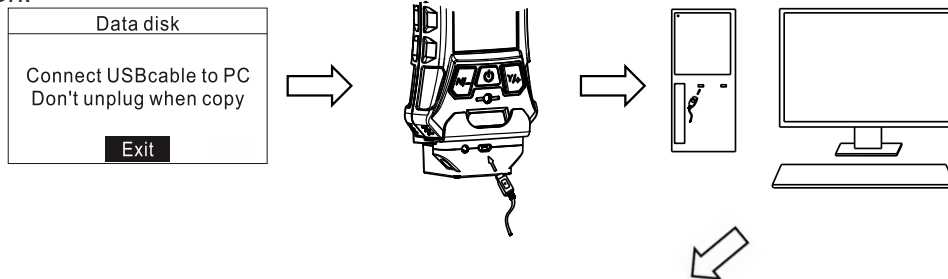

名称	修改日期	类型
ALL_ALARM_DATA	2020/6/29 0:00	文件夹
HIGH_ALARM_DATA	2020/6/29 0:00	文件夹
HISTORY_DATA	2020/6/29 0:00	文件夹
LOW_ALARM_DATA	2020/6/29 0:00	文件夹
MAX_DATA	2020/6/29 0:00	文件夹
MIN_DATA	2020/6/29 0:00	文件夹

Data export operation:

- Press [Y/+] to confirm and enter the data disk interface
- Connect the instrument to the charging base (same as battery charging operation)
 - Insert one end of the USB data cable into the USB port of the charging stand and the other end into the USB of the computer.
 - Open the "HISTORY-DATA" folder in the "Removable Disk" on the computer.
 - The "2020.06.29.CSV" file is "copy" or "cut" to the computer, and the data copy is completed.

Note:

1. Do not unplug or plug the USB data cable during the data copy process.
2. The instrument should be kept on the data disk interface during the data copy process, and please do not operate the instrument during the copy process.

14.6 Full option

After the data is full, there are two options:

1. Stop when full: stop data storage.
2. Cover history data: loop overwrite the data at the beginning.

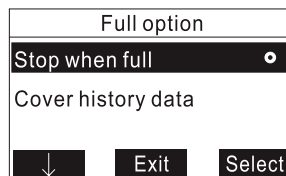

- Press [N/-] to move the cursor, press [Y/+] to select and confirm.

14.7 Clear record

The user can use this function to clear the historical data saved in the instrument.



Data clear operation:

- Press [Y/+] to enter the data record clear interface
- Press the [Y/+] key to select "Yes", the interface displays "Processing", and finally displays "Clear succeed" and the operation is complete .

Note: The data cannot be recovered after being cleared, please use this function with caution.

15、Monitor Set

15.1 Pump on/off

When the pump is working normally, the pump status icon at the top of the detection interface will appear alternately:



This icon display represents the pump is off:

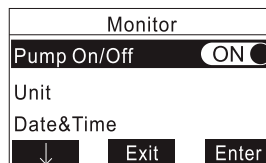

Turn the pump on and off:

Enter the instrument setting menu, press the [Y/+] key to switch to ON/OFF state, or press and hold the [Y/+] key for three seconds on the detection interface.

Note: Do not turn off the pump except in special circumstances.

15.2 Unit

This function is used to change gas unit.

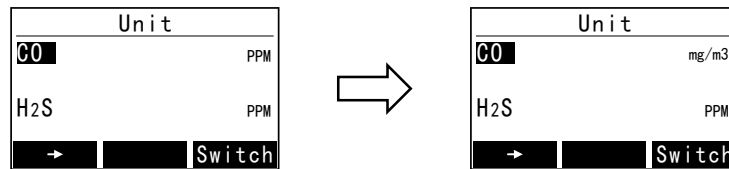

- Press [Y/+] key to switch gas units.

15.3 Date and time set

The date is set to "year/month/day", and the time is set to a 24-hour format system, respectively, "hour : minute : second".

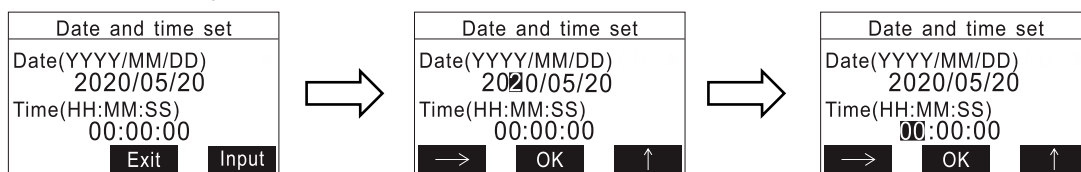

The body setting steps are:

- First press the [Y/+] key to confirm the input, and then continue to press the [Y/+] key to increase to the desired number.
- Press [N/-] to move the cursor.
- After inputting, press [MODE] to confirm.
- If you make a mistake, press the [N/-] key to cycle through the numbers, and then press the [Y/+] key to change the number of each position.

15.4 Language

The instrument has two language options, Chinese and English.



- Press [N/-] to switch options, press [Y/+] to confirm.

Note: Other languages can be customized.

15.5 Display Set

15.5.4 Brightness

The user can manually adjust the brightness of the LCD screen to adapt to some special test environments, such as extreme temperatures and environments with different brightness/darkness.

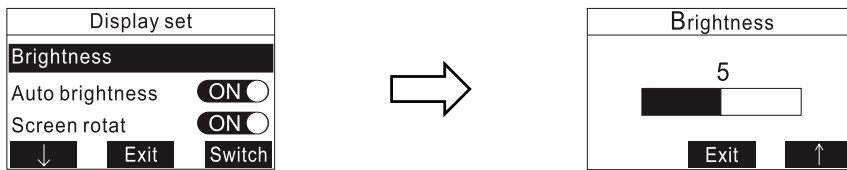

- Press [Y/+] first to enter the brightness setting interface.
- Then press the [Y/+] key to adjust the brightness of the LCD screen.
- Finally press [MODE] to save and exit.

15.5.2 Auto brightness

After turning on, the instrument can automatically adjust the brightness of the LCD screen according to the brightness of the surrounding environment.

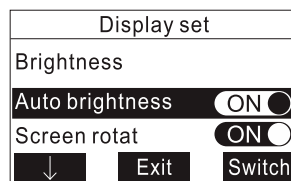

- Press [Y/+] key to turn on or off automatic brightness adjustment.

15.5.3 Screen rotation

In the detection interface, when the state of the instrument is reversed, the vertical/horizontal state sensor of the instrument can automatically rotate the display content by 180° for easy viewing.

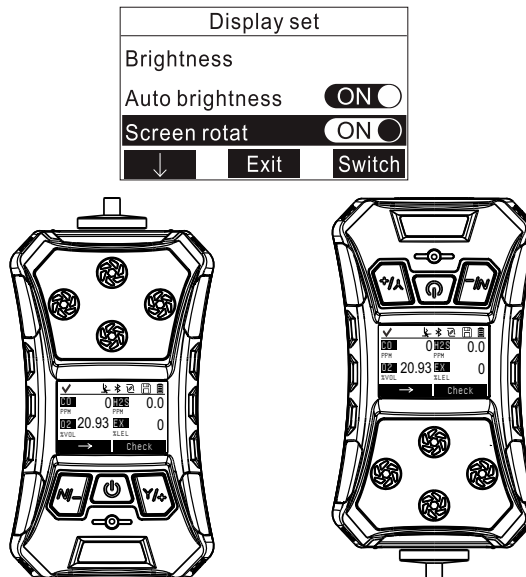

- Press [Y/+] to turn on or off the automatic screen rotation.

15.5.4 Sleep mode set

Sleep mode allows the user to modify the LCD screen on time, the time can be 15 seconds-30 minutes optional, or choose to keep the screen on.

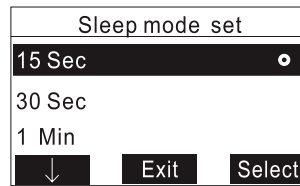

- Press [N/-] to switch options, press [Y/+] to confirm.

14.6 Security and Privacy

14.6.1 Modify Password

To enter the "menu", you need to enter a 4-digit password for verification. The initial password is "1234". The user can modify the verification password through the password modification function.

Password modification settings:

- First press the [Y/+] key to confirm the input, and then continue to press the [Y/+] key to increase the number from 0-9.
- Press and hold the [N/-] key to move the cursor.
- After entering two identical 4-digit passwords, press [MODE] to confirm.

14.6.2 Site ID and User ID

The site ID and user ID number information can be displayed by shortcut keys in the shutdown state, which is used to quickly identify the site and user of the instrument, and the four-digit unit/user number as a specific identification is also part of the data record (Will exist in the export data record table).

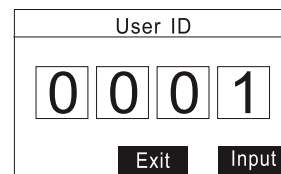
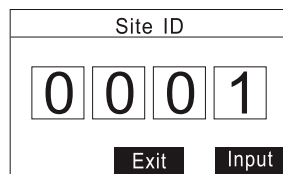

Site ID and user ID settings,

- First press the [Y/+] key to confirm the input, and then continue to press the [Y/+] key to increase the number from 0-9.
- Press [N/-] to move the cursor.
- After entering the 4-digit ID, press [MODE] to save and exit"

14.7 Self-test

The user can set the add-on items for the power-on self-test projects, the add-ons have STEL alarm value, TWA alarm value, Storage info, calibration info.

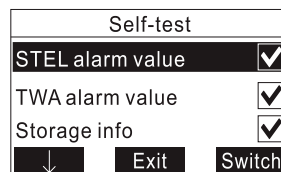

- Press [N/-] to move the cursor, press [Y/+] to switch whether to open the add-in.

14.8 Reset

14.8.1 Reset Sensor

This function can restore the sensor of the instrument to the factory calibration parameters.

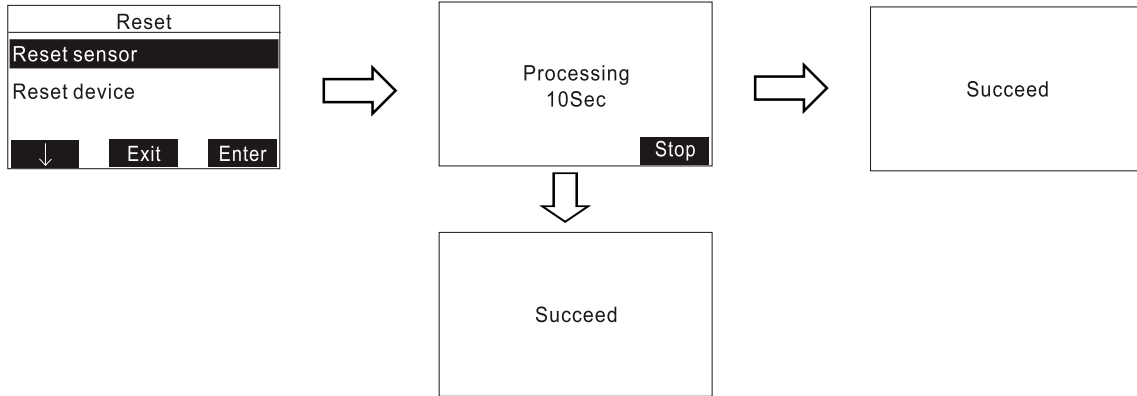

- Press the [Y/+] key to confirm the selection and restore, during which a 10-second countdown will be displayed. During the countdown, press the [Y/+] key again to terminate the restoration setting.

14.8.2 Reset device

This function can restore the settings of the instrument's various parameters (except the sensor calibration parameters) to the factory parameters.

- Press the [Y/+] key to confirm the selection and restore, during which a 10-

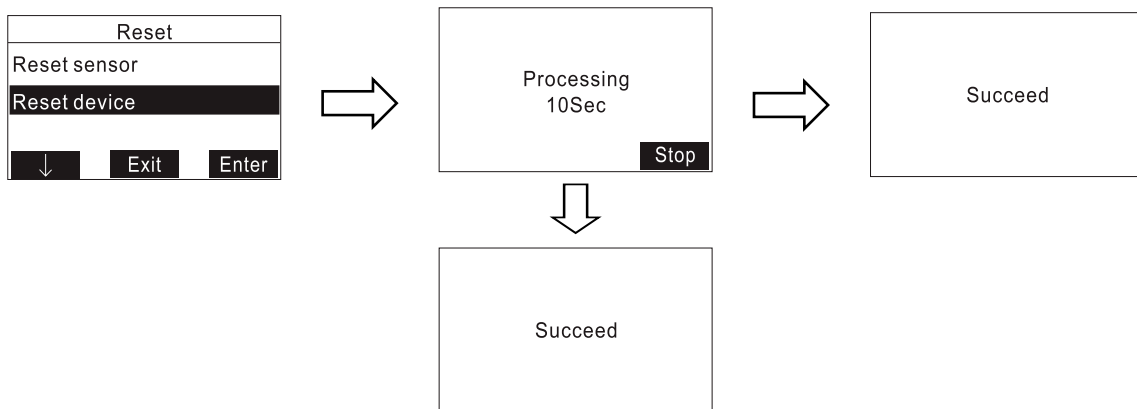

second countdown will be displayed. During the restoration of the instrument settings, press the [Y/+] key again to terminate the restore settings.

Note: The function of restoring factory settings is an irreversible operation. After setting, the parameters set by the user will be cleared and cannot be restored. Please use this function carefully.

14.9. Bluetooth function

The Bluetooth 5.0 of the instrument supports connection and communication with hand held devices of Android 4.3 and above or iPhone 4S and above. It follows the standard modbus protocol to realize the active acquisition and control of the

instrument by the host, and uses the extended command format to complete the handheld device to actively issue query instructions to obtain real-time concentration, Alarm function. The user can judge whether the instrument has enabled the Bluetooth function by checking the presence of the Bluetooth icon at the top of the detection interface.

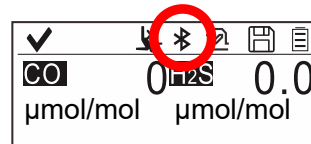
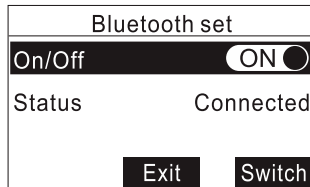

- Press [Y/+] to turn on or o the Bluetooth function.

Note: Bluetooth function is an optional function, instruments without Bluetooth function do not have this menu.

16、About

16.1 Monitor Information

Device information includes software Version, Site ID, User ID, date of Factory.

Monitor info	
Version:	V1.2.7
Site ID:	0001
User ID:	0001
Factory	2021-05-20
Exit	

16.2 Sensor information

Sensor information includes Gas type, Range, ADC value.

Gas	Range	ADC
CO	1000	0
H ₂ S	99.0	0
O ₂	30.0	0
EX	100	0
Exit		

16.3 Calibration record

The calibration record contains the date of the last calibration and the recommended date for the next calibration.

Calibration record	
Last calibration date	2020-05-20
Next calibration date	2020-08-20
Exit	

17、 Common faults and solutions

Fault phenomenon	Possible cause of fault	Solution
Unable to turn on	The voltage is too low	Please charge in time
	Crash	Please contact the dealer or manufacturer for repair
	Circuit failure	Please contact the dealer or manufacturer for repair
No response to detection gas	Circuit failure	Please contact the dealer or manufacturer for repair
The display is inaccurate	The sensor has expired	Please contact the dealer or manufacturer for repair
	Long-term uncalibrated	Please calibrate in time
The time display is wrong	The battery is completely exhausted	Charge it in time and reset the time.
	Strong electromagnetic interference	Reset time
Zero point calibrator function is not available	Excessive sensor drift	Calibrate in time or replace the sensor
	For over-range use	Please contact the dealer or manufacturer for repair
When the instrument normally detects, the interface displays the full scale	Sensor failure	Please contact the dealer or manufacturer for repair
Self-check failed	The sensor cannot be found	1. Restart the instrument 2. Please contact the dealer or manufacturer for repair
	Memory read failure	Please contact the dealer or manufacturer for repair
	The pump does not run	1. Enter the menu and turn on the pump switch to see if it runs normally 2. If the pump is blocked or damaged, please contact the distributor or manufacturer

18、 Terms of Service

18.1 Warranty Commitment

The company promises that all detectors manufactured by the company will be calibrated with the relevant standard gas of specific concentration. After purchasing the company's products, users do not need to calibrate the target point of the detector by themselves, and the operation must be performed by professional and technical personnel. Under the guidance of All the gas detectors of this series purchased through our distributors will provide you with a 12-months warranty service from the date of purchase.

This commitment is limited to the mainframe since the purchase, excluding accessories. During the service period, if under normal use and maintenance conditions (non-human factors), the product itself has a component that has a fault, and our inspection is true, you will receive our free service for you.

18. 2 Fault repair time

When your machine needs to be repaired, we will repair it for you and return it within 7 valid working days after receiving the machine you sent back. In case of special circumstances, if the repair cannot be completed within 7 effective working days, our staff will call you in advance to negotiate the repair date.

The aforementioned repair date does not include the return time.

18.3 Limited liability guarantee

After your product is repaired by our maintenance organization, it will continue to enjoy the promise of the original warranty period.

When you need warranty service, please present a valid warranty certificate, including a warranty card and purchase invoice or purchase contract.

When there is a situation listed in the warranty statement that is not within the scope of the warranty, you can choose paid repair services.

If the repair parts exceed the free warranty period, please pay a certain repair service fee. The standard of the repair service fee is provided by our maintenance organization.

We have the right not to provide warranty service if the product is damaged due to the following conditions:

- 1) Damage caused by man-made.
- 2) Damage caused by violation of operating regulations and requirements.
- 3) Damage caused by all natural disasters such as floods and fires.
- 4) Damage caused by harsh environment.
- 5) Repair, alter, modify or disassemble this product by unauthorized service personnel.

19、 Technical support and manufacturer