



GasDog

Gas Detector Catalog



Welocom to visit our website!

Any questions, please contact us..

E-mail: sales@gasdog.com

Phone: +86 773-280-9002

Website: GasDog.com

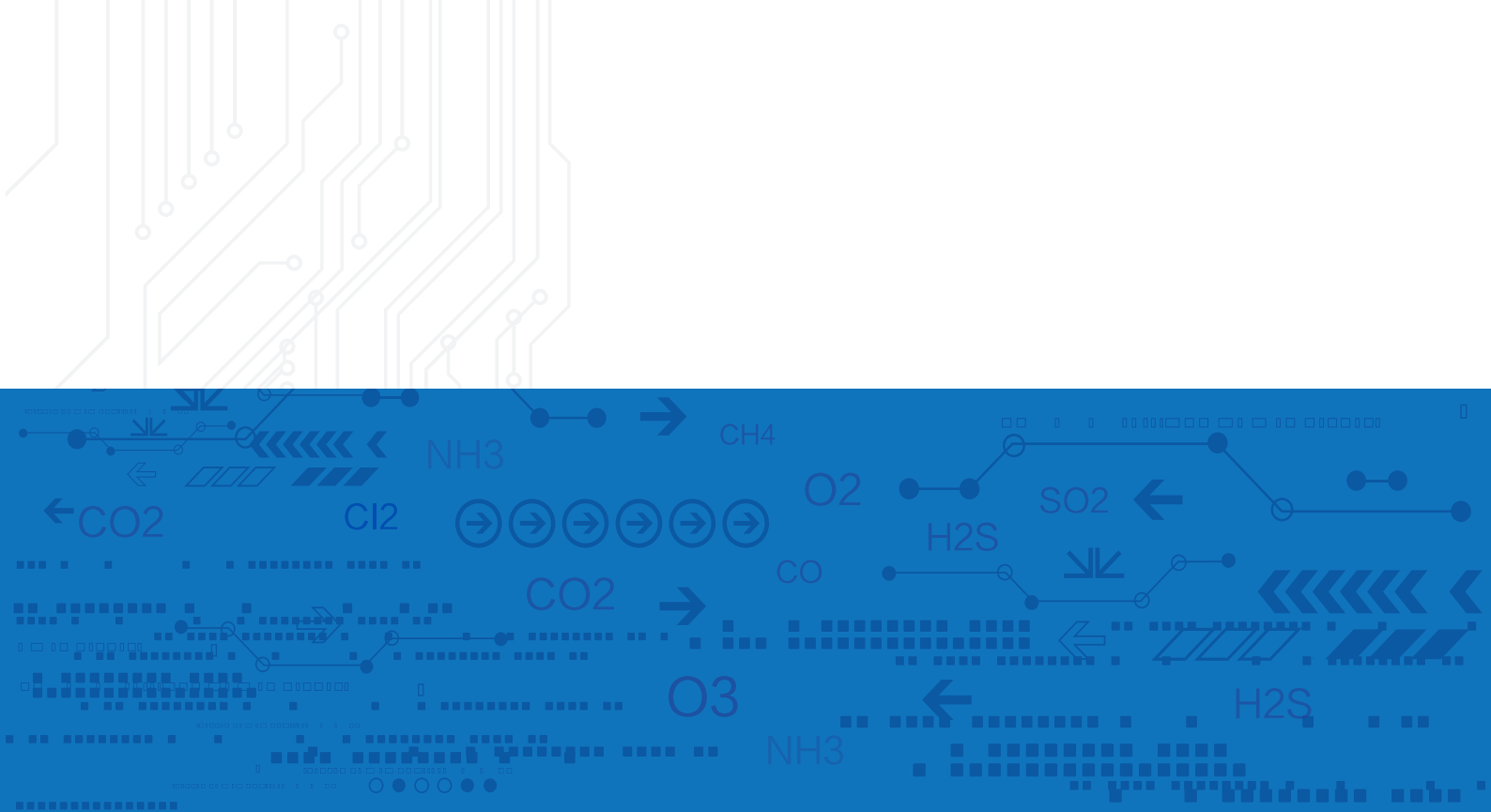

GD200
gas detectors are imported
with world top imported
sensors

GD200

Portable Gas Detector

Product overview

GD200 series gas detector is a kind of fast response and high accuracy gas measurement device. With internal sam-pling pump, fast sampling speed and high flow rate, ensuring the response time of the detector. Unique design, small size and easy to carry with. Special high intensity engineering plastics housing, suitable for different kinds of situation and environment. We dedicate to provide you the most reliable, accurate and the safest solution of gas detection.



—
Specialized in Gas Detection
For 16 Years

Product Advantages

Product advantages

- Employing original imported first-class brand sensor.
- (optional) High speed data transmission by USB, which can download and print data.
- LCD dot matrix display, the gas type, unit, concentration, local time can be showed on the screen.
- Support Chinese and English operation, easy to shift.
- The gas concentration unit PPM and mg/m3 can be shifted quickly. Built-in micro sampling pump, 10 grades of suction are available.
- Explosion-proof certification, explosion-proof grade: II 2G Ex ia IIC T4 Ga IP66.

Functions

- Monitor the specified gas concentration in environment and enclosed space and alarm.
- With Self-calibration and zero calibration functions, makes the detection more accurate and reliable.
- One press to restore factory setting, free from the bother of mis-operation With temperature and pressure compensation, this is able to realize gas concentration compensation under conditions of different temperatures or pressures.
- Two-stage alarm with sound and light, alarm point is settable.
- Rechargeable lithium polymer battery of large capacity.
- Employing pumping sampling method and the pumping suction is adjustable.
- Special engineering plastics housing of high intensity, anti-skipping, water-proof, dust-proof, explosion-proof.
- Elegant and exquisite aluminum alloy suitcase



GD200 portable gas detector

Application



▲ Petrochemical & Chemical Industry



▲ Municipal Engineering & Utilities



▲ Agricultural & Environmental Protection



▲ Electronic



▲ Food & Pharmaceutical Industry



▲ Other Industries

Accessories & Configuration List

Standard Accessories

- GD200
- Aluminum suitcase
- A charging adapter
- Instruction
- Qualification certificate

A charging adapter

GD200
Pumping Gas Detector

Instruction

Aluminum suitcase



Technical Specification

GD200

Gas Detected	O2, N2, CO2, EX, VOC, PH3, etc. According to customers' requirements.
Detection principle	Electrochemistry, infrared ray, catalytic combustion, PID photo ionization (according to the target gas and sensor).
Sampling Method	Pumping suction, flow rate can up to 1L/min, ten grades of pumping suction for selection.
Measure Range	The range is optional, according to the target gas and the sensor.
Resolution	According to sensor and measure range
Precision	According to sensor.
Signal Output (optional function)	High-speed data transmission by USB, available for data downloading and printing
Response Time	≤ 10S
Repeatability	≤ ± 1%
Zero shift	≤ ± 1% (F.S/year)
Operating language	English
Temperature	-20℃ ~ 50℃
Explosion-Proof	II 2G Ex ia IIC T4 Ga IP66.
Alarm mode	Sound, light, vibration
Dimensions	205*75*32mm
Recovery Time	≤ 10S
Linearity error	≤ ± 1%
Display	LCD dot matrix display
Gas unit	Units are switchable
Humidity	0-90%RH
Degree of protection	IP66
Operating time	100h (pump off) , 12 hours(pump on)
Weight	300g

Normal gas types and paramaters (Other gases are not listed can be customized)

Detected gas	measure range	Optional ranges	Resolution	Response time
Flammable gas (EX)	0-100%LEL	0-100%VOL	0.1%LEL/0.1%VOL	≤ 10S
Oxygen (O2)	0-30%VOL	0-25%VOL	0.01%VOL/0.1%VOL	≤ 10S
Carbon monoxide (CO)	0-1000ppm	0-2000ppm	0.1ppm/1ppm	≤ 10S
Hydrogen sulfide (H2S)	0-100ppm	0-1000ppm	0.01ppm/0.1ppm	≤ 10S
Ammonia (NH3)	0-100ppm	0-200ppm	0.01ppm/0.1ppm	≤ 10S
Chlorine (CL2)	0-10ppm	0-100ppm	0.01ppm/0.1ppm	≤ 10S
Hydrogen Chloride (HCL)	0-20ppm	0-100ppm	0.01ppm/0.1ppm	≤ 10S
Nitric oxide (NO)	0-100ppm	0-250ppm	0.01ppm/0.1ppm	≤ 10S
Nitrogen dioxide (NO2)	0-20ppm	0-100ppm	0.01ppm/0.1ppm	≤ 10S
formaldehyde (CH2O)	0-10ppm	0-50ppm	0.01ppm/0.1ppm	≤ 10S
Ozone (O3)	0-10ppm	0-100ppm	0.01ppm/0.1ppm	≤ 10S
Carbon dioxide (CO2)	0-2000ppm	0-100%VOL	1ppm/0.01%VOL	≤ 10S

Project Cases



- ◀ GD200
Used in Large oil refinery and metallurgical plant,etc
- ▼ GD200
Applied in Repair shops, mines, sewers,etc



- ▶ GD200
Used in laboratory, pharmaceutical factory,etc
- ▼ GD200
Applied in warehouse,workshops,etc







More Application

- Furniture, Floor, Wallpaper, Coating, Gardening, Interior Decoration and Renovation, Dyestuff, Papermaking, Pharmacy, Health Care, Foodstuff, Antiseptic.
- Disinfection, Chemical Fertilizer, Resin, Adhesive, Pesticide, Raw Material, Sample, Technological Process,
- Livestock Farm, Refuse Processing Plant, Perm Place.
Bio-pharmaceutical Plant, Green Household, Livestock Breeding, Green House Cultivating, Warehouse Logistics, Brewing And Fermentation, Agricultural Production.

User Manual-GD200

Thanks for purchasing our product. Please read the user manual carefully before using.

Keys Operation:

	Turn on/off: long press for 3s to turn on/off the device, short press to confirm or save data.
	Menu: in detection mode, press this button to enter into parameter setting mode, and in parameter setting mode, press this button to move the cursor.
	Plus: in parameter setting mode, short press it to select items upward or add value. Long press for 3 seconds to turn on/off alarm function quickly.
	Minus: in parameter setting mode, short press it to select items downward or decrease value. Long press for 3 seconds to turn on/off air pump quickly.
	Exit: in parameter setting mode, short press it to go back to previous menu. Long press to shift the gas concentration unit quickly.

(Note: The long press function only work in detection mode. When you change or reset any data, please remember to click "ON/OFF" button to confirm and save the settings. Remember to turn on the pump when start the detection. Please turn off the pump when there is no need to detect, which will be helpful for the service life of the pump)

Power On / Off

Put the detector in clean air, and press the "ON/OFF" for three seconds, the detector will be turned on and the pump will start to work. The screen displays the following interface successively: Brand and Logo, main parameter interface, initialing countdown. The countdown would be 60 or 120 seconds, which is to make sure that the sensors are fully activated. After countdown, the device enter normal detection interface.

Take the detector out of the detected environment and wait for the data to get down to zero, then press the "ON/OFF" to turn off the detector

Zero Calibration

Zero calibration must be done in clean air. Better to do once after alarming happens.

Press "MENU" to enter parameter setting mode, select the "calibrate zero", and press "ON/OFF" to enter the mode.

Observe the value of "real time concentration". If the reading is not zero and the drifting is too big when the reading is stable, then it is necessary to conduct zero point calibration.

Press "ON/OFF", the real-time concentration will go back to zero, and press "ESC" to go back to detection mode, gas concentration values also back to zero.

Note: Zero calibration of oxygen detector, nitrogen detector and carbon dioxide detector (target gases are component of the air) can not be done in the air. Only the target point calibration (value of target point concentration is the standard concentration values in the clean air) can be done.

Process of Over-range incorrect operation

Users should avoid using gases which exceed the measure range to impact the sensor, because it will affect the lifespan and sensitivity of the sensor, even, "poison" the sensor. If there is any over-range incorrect operation makes the detector displaying an concentration at a large reading, the remedy is to take the device out of the environment immediately and put it in clean air for over half an hour, and then observe the reading, if it keeps going down, then wait until the reading back to zero before powering it off, and do the zero point calibration next time before using it. If the reading maintained at full scale, user should send the device back to manufacturer or agent for repair or replacing the sensor.



Note

*If detector is used for the gas cylinder detection, considering the high pressure in the cylinder, please use a pressure regulator, and keep it as the below data:

Flow rate: 800mL~1L/minute

Pressure: 0.1MPa or 1Bar

*Please put the detector in clean air for about 5 minutes and waiting for the data falling down to normal before turning it off after measurement.

Operation Interface

When the detector is turned on completely, the device will enter the detecting interface. The gas type will be showed on the top left, and the time and battery power will be at the right. In the middle, there is the real-time concentration. If the detector is with data storage function, there will be the storage status at the top of the concentration: ON or OFF, and the total storage number. There will be BEEP-ON at the bottom left, which means the alarm is on. The PUMP-ON at the bottom right, which means the pump is working.

Alarm Status

When the detected gas concentration is higher than the low alarm value, the alarm sound will be on, yellow light will be flickered.

When the detected gas concentration is high than the high alarm value, the alarm sound will be on, red light will be flickered.

Alarm Setting

Press “Menu”, choose the “Alarm point set”, and start to set the alarm value.

There are LOW POINT and HIGH POINT for set, press “MENU” to move the cursor to the value you want to set, and press the “PLUS” or “MINUS” to change the value. After the setting is done, press “ON/OFF” button to save the settings.

Low Battery Alarm

When the battery is low, there will be sound, light low battery alarm. There will be sound and light every 5 seconds to remind the user to charge the device in time. When the battery is used up, the device will be turned off automatically.

Restore Setting

When all the settings are wrong, or users operate the detector in a wrong way, you can restore the detector to factory settings. But if the detector works normally, please don't operate this setting. In order to avoid wrong setting, password is needed. If you want to restore the detector to factory setting, please contact the supplier.

Storage set

In the storage setting, you can set the storage status and the interval. Every time you turn on the detector, the storage status defaults OFF, so you need to set the storage status if you want to record the data.

Press MENU, choose the “Storage set”, move the cursor by pressing MENU at the “ENABLE”, press MINUS to change NO to YES.

The storage interval can be 5 seconds, 10 seconds, 15 seconds, etc. The highest interval is 1 hour.

View history data

Press the MENU, choose “view history data”. Then at the top is the record total number, and the reminder “PLEASE SELECT”. Now, if you press MINUS, then the record data will be from the first record to the second in turn. If the record number is above 10, and you want to check the specific number, you press the MENU again, then you can input the exact number and check that record (press the MENU to move the cursor, and press the MINUS and PLUS to change the number), press ON/OFF to confirm and then you will see the detailed record. In the detailed record interface, at the top are the record total number and current number. In the middle are the date and time, and the concentration is at the bottom.

Erase history data

To make sure the detector work perfectly and you can check the history data quickly, we suggest you to erase the history data regularly. Press MENU, choose the “Erase ex_flash”, password is needed (the password is 9999), then press ON/OFF, it shows that “erasing”, and when finished, it will turn back to the detecting interface.

Target Point Calibration

Note: Calibration needs to be done by professionals and with necessary accessories and standard gas.

Prepare the standard gas before starting the target point calibration. In detection mode, press “MENU”, select “calibrate span”, press ON/OFF button to enter. Then you will need to enter password. (If you need password, please contact the manufacturer to get it)

After entering the password successfully, press ON/OFF to enter the target point calibration interface, as shown in the picture. The interface will display “concentration”, “set value. The concentration is the result got from the calculation of several internal calibration parameters. The process of calibration is the process to recalculate the internal parameters of the device. The set value is the value need to be entered manually; it should be the concentration of the standard gas to be calibrated. Select the parameter under the current interface, modify its value with “PLUS” and “MINUS” button.

The calibration process is as below:

1. Connect the detector with standard gas cylinder by hose.
2. Enter the target point calibration interface, set the “SET value” as the standard gas concentration.
3. Release the standard gas to the detector in a flow rate of 500mL/min. The value of “concentration” will become larger gradually, and become stable after 30seconds.
4. When the value of “concentration” is stable, press the “ON/OFF” button, the value of “concentration” will be same with or almost same with the “Set value”. The calibration is finished.
5. Cut off the standard gas supply. Press “ESC” to go back to detection interface.

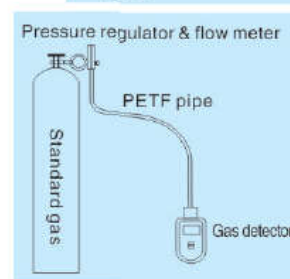
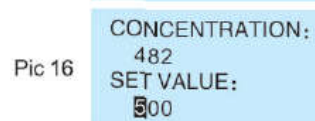
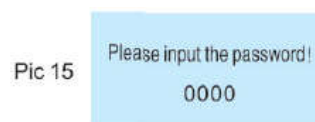

Pic 17



GD300
online fixed gas detector

GD300

Online Fixed Gas Detector

Product Overview

GD300 concentration in different kinds of situations or pipelines 24h continuously wall mounted type gas detector. Using world first brand sensors, and advanced micro-process technology, with data display, fast response, high precision and good stability. Powered by 24V DC, with 4-20mA, RS485, relay signal output. Explosion proof, suitable for different kinds of situations.

Product Advantages

Product advantages

- Employing overseas original sensor.
- Standard equipped with three-wire system 4-20mA analog output; relay output; RS485 output (optional)
- Unique infrared ray control function, which can non-contacted control the device. Being compatible with all kinds of controlled alarms, PLC, DCS and other control system, can be remote monitored.
- Alarm mode: Sound and light, alarm value is settable(Optional)
- Explosion-proof design, fast, reliable and stable.
- Explosion-proof grade: II 2G Ex db IIC T6 Gb IP65
- With self-calibration function and three standard keys will be used to realize on-site maintenance.

Features

- Monitor the specific gas concentration in environment or pipeline and alarm.
- With self-calibration and zero calibration function, makes the detection more accurate and reliable.
- With temperature compensation, this is able to realize gas concentration compensation under conditions of different temperatures.
- Infrared ray controller can remote control alarm point settings, zero calibration, and address modification.
- Can output one or two on-off signals, can drive ventilator or solenoid valve and other external devices.
- Working Voltage: 12-36V DC
- Case: die-cast aluminum



GD300
online fixed gas detector

Application



▲ Petrochemical & Chemical Industry



▲ Municipal Engineering & Utilities



▲ Agricultural & Environmental Protection



▲ Electronic



▲ Food & Pharmaceutical Industry



▲ Other Industries

Technical Specification

GD300 online fixed gas detector

Gas Detected	O ₂ , N ₂ , CO ₂ , EX, VOC, PH ₃ , etc. According to customers' requirements.
Detection Principle	Electrochemistry, infrared ray, catalytic combustion, PID photo ionization (according to the target gas and sensor).
Install Method	Wall-mounted, piping type, flow-type (according to the detected environment)
Measure Range	The range is optional, according to the target gas and the sensor.
Resolution	According to sensor and measure range
Precision	According to sensor.
Output signal	4-20mA, 0-5V, RS485, relay (optional)
Response Time	≤5S
Repeatability	≤±1%
Zero shift	≤±1% (F.S/year)
Connection mode	G1/2 external thread explosion-proof flexible pipe
Temperature	-20℃ ~ 50℃
Explosion-Proof	II 2G Ex db IIC T6 Gb IP65
Power	12-36V DC
Dimensions	180×150×90mm
Recovery Time	≤10S
Linearity error	≤±1%
Relay output	220V AC 3A (optional)
Thread Size	M45*2mm
Humidity	0-95%RH
Degree of protection	IP65
Operating time	24h
Weight	≤1.6kg

Normal gas types and parameters (Other gases are not listed can be customized)

Gas	Measure range	Optional	Resolution	Response time
Flammable gas (EX)	0-100%LEL	0-100%VOL	1%LEL/0.1%VOL	≤10S
Oxygen (O ₂)	0-30%VOL	0-25%VOL	0.01%VOL/0.1%	≤10S
Carbon monoxide (CO)	0-1000ppm	0-2000ppm	VOL 0.1ppm/1ppm	≤10S
Hydrogen sulfide (H ₂ S)	0-100ppm	0-1000ppm	0.01ppm/0.1ppm	≤10S
Methane (CH ₄)	0-4%VOL	0-100%VOL	0.01%VOL	≤10S
Ammonia (NH ₃)	0-100ppm	0-200ppm	0.01ppm/0.1ppm	≤10S
Chlorine (CL ₂)	0-10ppm	0-100ppm	0.01ppm/0.1ppm	≤10S
Hydrogen Chloride (HCL)	0-20ppm	0-100ppm	0.01ppm/0.1ppm	≤10S
Hydrogen (H ₂)	0-1000ppm	0-40000ppm	0.1ppm/1ppm	≤10S
Nitric oxide (NO)	0-100ppm	0-250ppm	0.01ppm/0.1ppm	≤10S
Nitrogen dioxide (NO ₂)	0-20ppm	0-100ppm	0.01ppm/0.1ppm	≤10S
Nitrous Oxides (NOX)	0-100ppm	0-2000ppm	0.01ppm/1ppm	≤10S
formaldehyde (CH ₂ O)	0-10ppm	0-100ppm	0.01ppm/0.1ppm	≤10S
Ozone (O ₃)	0-10ppm	0-1000ppm	0.01ppm/0.1ppm	≤10S
Carbon dioxide (CO ₂)	0-2000ppm	0-50000ppm	0.1ppm/1ppm	≤10S
sulfur dioxide (SO ₂)	0-20ppm	0-5000ppm	0.01ppm/1ppm	≤10S
Ethylene oxide (ETO)	0-100ppm	0-1000ppm	0.01ppm/1ppm	≤10S
Phosphine (PH ₃)	0-10ppm	0-5000ppm	0.01ppm/1ppm	≤10S
Hydrogen cyanide (HCN)	0-10ppm	0-100ppm	0.01ppm	≤10S
Nitrogen (N ₂)	0-100%VOL	0-90%VOL	0.01%VOL	≤10S
Hydrogen fluoride (HF)	0-10ppm	0-50ppm	0.01ppm	≤10S

Project Cases



- ◀ GD300
Applied in power plant, hazardous chemicals plant, etc.
- ▼ GD300
Application in sewage treatment, refuse treatment station, etc.



- ▶ GD300
Used in warehouse, freezer, etc.
- ▼ GD300
Used in steel mills, repair shops, etc.

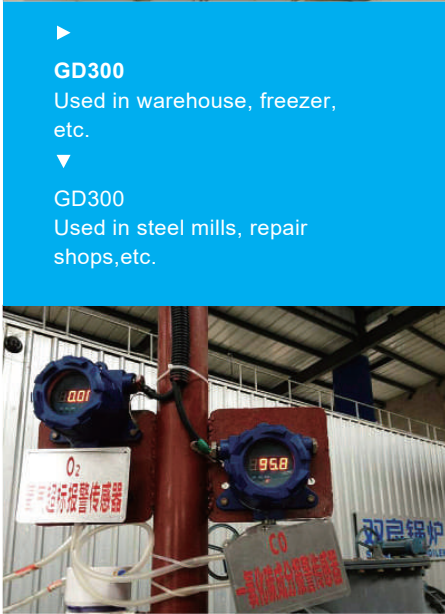

More Application

- Furniture, Floor, Wallpaper, Coating, Gardening, Interior Decoration and Renovation, Dyestuff, Papermaking, Pharmacy, Health Care, Foodstuff, Antiseptic.
- Disinfection, Chemical Fertilizer, Resin, Adhesive, Pesticide, Raw Material, Sample, Technological Process, Livestock Farm, Refuse Processing Plant, Perm Place.
- Bio-pharmaceutical Plant, Green Household, Livestock Breeding, Green House Cultivating, Warehouse Logistics, Brewing And Fermentation, Agricultural Production.

online fixed gas detector GD300:XX Instruction Manual



Notice to Reader

Please read this instruction manual before using the detector

Matters need attention

A. Please read this instruction manual before using the detector.

B. The detector must be used in compliance with the designated procedures of our company. C. The warranty period of this transmitter is 12months (starts from the date user get the detector).

Users should comply with the instructions in the use of this detector. Any damages or malfunctions caused by improper operation of users are not within the scope of warranty.

D. Repair and replacement of any parts must be operated by trained staff under authorization of our company, using original spare part. The operator is responsible for the liability if users operate the repair or replacement by themselves.

E. There is acid solution inside the transmitter, please do not disassemble it. And pay attention not to damage the frontal membrane of the transmitter. If the skin is stained with the acid solution, the right remedy is to flush the stained skin continuously with clean water for 10 minutes.

F. The detector must be calibrated for once each year. The explosion proof sheet parts of the transmitter need to be cleaned

regularly (blow with low pressure compressed air), otherwise the detection sensitivity will be affected by the dust and impurities clogging protection hole.

Port Instruction

- 1.Power supply, signal line
- 2.Printed-circuit board
- 3.Terminal
- 4.Sound and tight alarm port
- 5.Air chamber of sensor
- 6.Sensor port
- 7.Main board connection

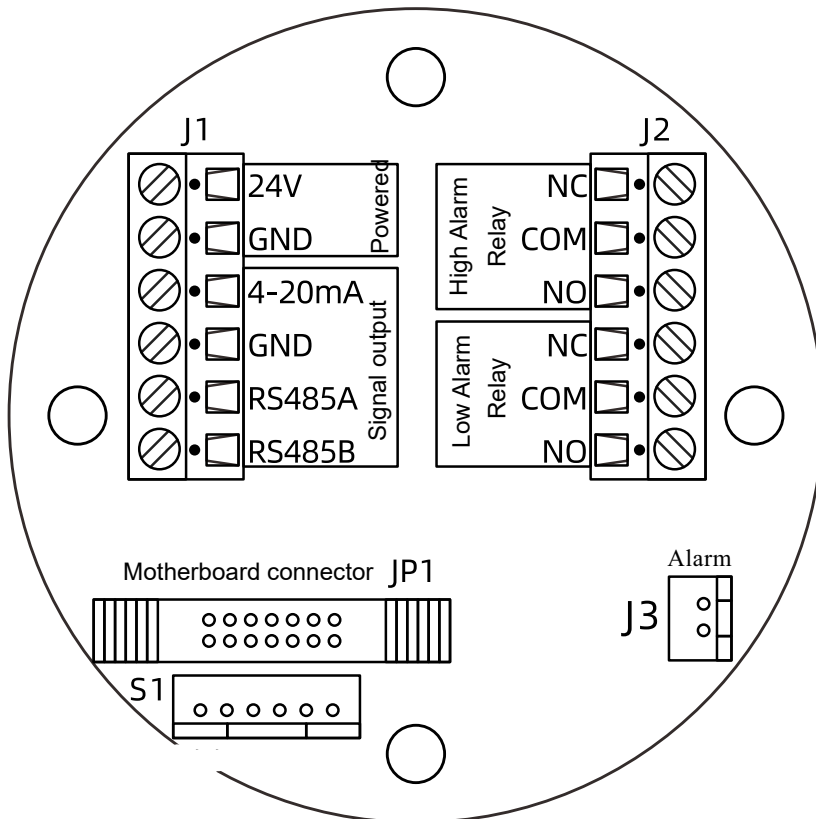
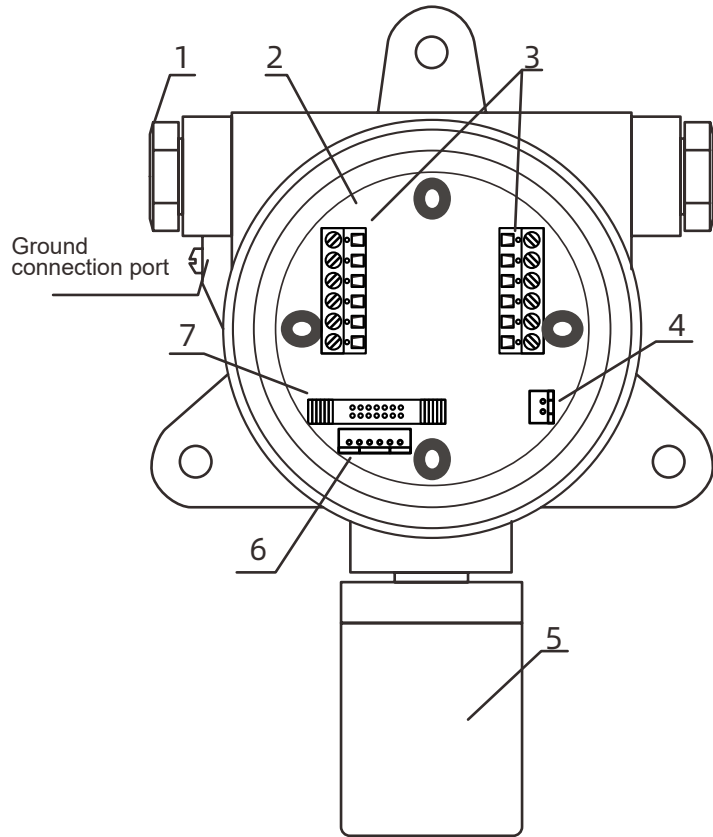

NC:Normally close
 NO:Normally open
 COM:Common
 24V:24+,positive
 GND:24-,negative
 4~20mA:4~20mA analog signal

Technical performance and parameters

1. Key Technical Indicator

Target gas	Range	Accuracy	least count	response time
O2	0-30%VOL	<±2%(F.S)	0.01%VOL	≤15
H2S	0-1000ppm	<±2%(F.S)	1ppm 1ppm	≤15
CO	0-1000ppm	<±2%(F.S)	1ppm 1ppm	≤25
H2	0-20000ppm	<±2%(F.S)	0.01ppm	≤15
CO2	0-10000ppm	<±2%(F.S)	0.1ppm	≤40
C2H4	0-100ppm	<±2%(F.S)	0.01%VOL	≤60
NO2	0-20.0ppm	<±2%(F.S)	1ppm	≤25
N2	0-100%VOL	<±2%(F.S)	0.01ppm	≤40
TVOC	0-6000ppm	<±2%(F.S)	0.01ppm	≤60
NH3	0-100ppm	<±2%(F.S)	0.1ppm	≤40
ASH3	0-10.00ppm	<±2%(F.S)	0.01ppm	≤30
C3H3N	0-200.0ppm	<±2%(F.S)	0.01ppm	≤40
F2	0-10 ppm	<±2%(F.S)	0.01ppm	≤25
O3	0-5.00ppm	<±2%(F.S)	0.01ppm	≤50
CL2	0-10.00ppm	<±2%(F.S)		≤60
BF3	0-10.00ppm	<±2%(F.S)		≤60

Repeatability: <2%

Zero drift: < ± 2% (F•S) /6M

Operating temperature: -20~+50°C

Environment temperature: <90%RH

Working principle of the transmitter: electrochemical for oxygen and hazardous gases, catalytic combustion for combustible gases

Lifespan of transmitter: 3years for combustible gas transmitter; 2years for hazardous gas transmitter

2. Other Technical Parameters

Inspection mode: diffusion

Working mode: fixed long-term continuous work Working voltage: 12-30V DC

Working current: oxygen and hazardous gas <50mA (Max)
combustible gas <150mA (Max)

Output signal: three-wire 4-20 mA standard signal output or RS485 signal output Exterior structure: die-casting aluminum housing

Dimensions: 135 x 125 x 116mm (without mounting bracket)
167 x 145 x 126mm (with bracket)

Weight: without mounting brackets 1.2kg with brackets 1.6kg with stent

Connection cable (6 core cable) is defined as

follows: 4-20mA with RS485:

Red: positive-input of power (12 to 24V)/ 24V+ Black:

ground wire of power/24V

Yellow:4-20mA output.

Orange: RS485A

Blue: RS485B

Brown: Free

Connection distance: >1000m

Protection grade: IP65

Installation type: on wall

Type of explosion-proof: flame proof Explosion-proof

grade: Ex d IIC T6 Gb

Inlet port: hexagonal locknut

Settings of Remote Control

The remote control applied to all product type produced by Yuante.

1. Press "MENU" once to enter F01, address code setting menu. Press "OK" to modify, press "+" "-" to modify address code of the detector. Press "OK" to save settings and "BACK" to cancel.

2. Press "MENU", then press "+" to enter F02, minimum value setting menu of gas alarm, Press "OK" to modify, press "+" "-" to modify the value. Press "OK" to save settings and "BACK" to cancel.

3. Continue to press "+" to enter F03, maximum value setting menu of gas alarm., Press "OK" to modify, press "+" "-" to modify the value. Press "OK" to save settings and "BACK" to cancel. Same operation with F04 (zero point calibration), F05 (range calibration), F06 (AD value).

4. Press "MENU" four times to enter a shift status, under this status:

Press "RESET" once, the data would be 255, one more it would be 0. Just press "RESET" to shift. When the data is 0, press "+" or "-" to modify alarm point, the data difference would be only 1. When the data is 255, press "+" or "-" to modify alarm point, the data difference would be 1000. "RESET" can also be used as mute button when it is alarming.

Remote controller function

MENU	MENU button, from the measurement state into the functional state
RESET	alarm reset to eliminate alarm function
OK	confirm button
+	plus
BACK	return
-	minus

Function

introduction: Controller

function introduction

F-01 Address, Range1-200

F-02 Low point alarm

F-03 High point alarm

F-04 Zero calibration

F-05 4mA offset correction

F-06 ADC check

F-07 Standard gas concentration

F-08 Calibration switch

F-09 Production date

F-10 Reserved function

F-11 Serial communication check. 0 no check, 1 odd check, 2 even check F-12

Arrangement mode of the floating-point data

0:DCBA

1:ABCD

2:CDAB

Need to press OK to save after all the above parameters are modified, which can take effect immediately, power outage restart also valid.

Installation Instruction

1. Location Selection

The location selection of the gas detection transmitter is essential to achieve the best detection results. In the selection of location, we need to consider the following factors: the density of gas in a leaking point, proportion of target gas, the impact of surrounding buildings, condition of production equipment, wind direction and annual meteorological conditions and even the location of windows and doors in an indoor environment.

We provide the following suggestions for your reference:

- A. Maintain a proper distance between the detector and the possible gas leaking point. It would react too fast or too frequent if the distance is not enough, which may paralyze people's mind.
- B. The detector must be located in the downwind of the possible leaking point.
- C. If installed indoor, but the source of the leak is outdoor, the detector must be installed at the air inlet.
- D. Determine the height according to proportion of target gas in air.
- E. Determine the quantity of detectors according to the condition of possible leaking point, frequency

of staff attendance and time of stay as well as the economic effect.

F. Consider to increase quantity of inspection point if the equipment is old.

G. Protect the detector from radiation of high temperature heart source. Environments of both very high temperature and very low temperature will affect the result and lifespan of the detector.

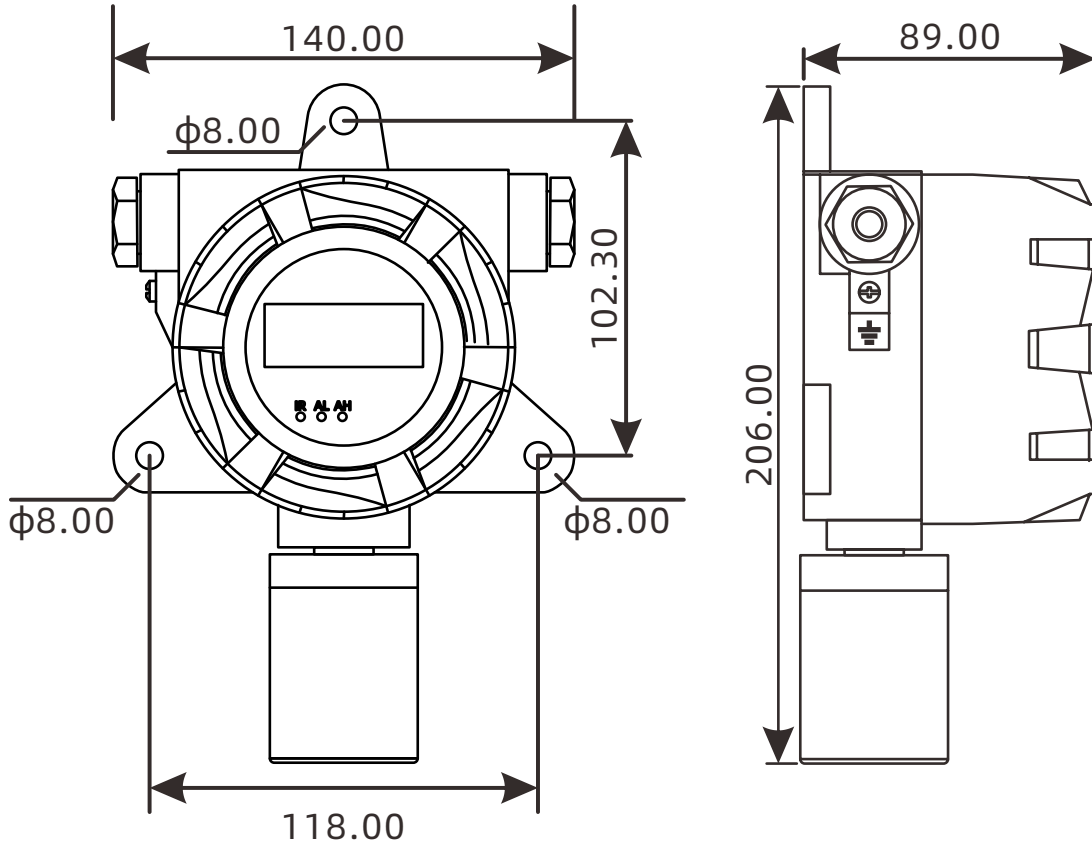

2. Steps of Installation

Connect wire to correspondent terminals. Don't work with power on. The arrangement of terminals

differs according to the type of transmitter. The definition of different wires:

Red: positive-input of power (12 to 24V)/24V+ Black: ground wire of power/24V
 Yellow:4-20mA output.
 Orange: RS485A
 Blue: RS485B
 Brown: Free

Fix the detector on the wall with expansion bolt, make sure the transmitter is downward, or the detector cannot work property. Users can also separate the bracket and transmitter according to the condition on spot, fix the bracket before connection.

For the sake of safety and interference reduction, please connect the housing with reliable ground wire. For the wire between the transmitter and the main engine, the shorter, the better. And protect the wire with iron pipe.

Method of Calibration

To guarantee the measurement accuracy of the transmitter, regular calibration and maintaining rigorous record is necessary.

Devices needed for calibration: a bottle of sample gas used for range calibration (60%F.S standard gas in normal site),relief valve, flow meter of 0~1000ml/min, transparent and smooth conduit for gas, standard gas housing, digital multimeter, stopwatch and etc.

Note: The value of transmitter WB (4mA) , WC (20mA) , Wz (zero potentiometer), WA (range potentiometer, also known as calibration potentiometer) and host alarm has been set right before it leaves the factory. User should not adjust casually. It is the value of zero potentiometer (Z) and calibration potentiometer (S) needed to be set on spot.

1. Zero Point Calibration

Open the detector in clean air, if there is readings after counting down.

Press the button "MENU" of the remote controller, the detector displays "F-01", press "+" or "-", change the function to "F-04", and click "OK". The detector value will be displayed as 0.

In the zero calibration of oxygen detection transmitter, we must use nitrogen of purity over 99.99%.

2. Range Calibration

1. Enter into "F-07" as the same way above .

The

"F-07" value is the concentration of the standard gas, initialized to half of the measure range. This value can be modified through the "+" and "-" keys to make it consistent with the standard gas concentration which need to be calibrated. Press

"OK" to exit.

2. Enter into "F-08" to change 0 into 1, then back to detection interface.

3. Connect the 200-400mL/min standard gas in detection interface, when the detector value is stable, press "OK" for 3 seconds, then the instrument will be calibrated automatically. The measured concentration value is consistent with the value set in "F-07".

4. After calibration, left the detector in the air for a while. Shut off the power when the detector value is close to zero.

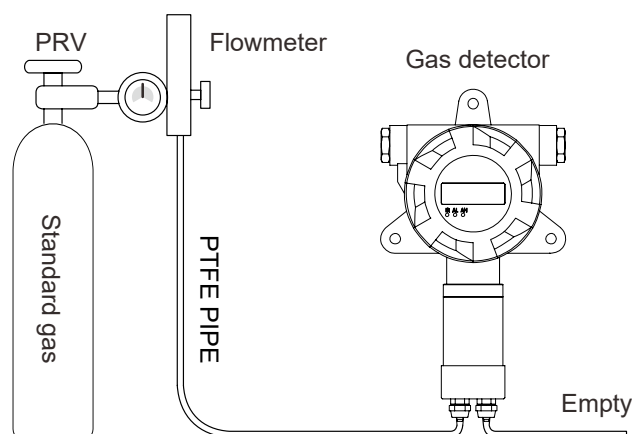

Common Malfunction, Repair and Maintenance

Symptom	Reason	Method to process
No output for transmitter	wrong connection	connect again
	potential in reference point is not correct	Adjust zero point gradually and then adjust potentiometer (4mA) Return to Yuante for repair
	Circuit fault	Calibrate again
Too low host reading	Value of S potentiometer setting is too small	Get a new transmitter
	Transmitter failure	Calibrate again
Too high host reading	Value of S potentiometer setting is too large	Get a new transmitter Wait for starting up
	Transmitter failure	Get a new transmitter
Instable host reading	Heat settling time is not enough	Return to Yuante for repair
	Transmitter failure	
	Circuit fault	

Product component

Fixed Gas Detector	one
Instruction Manual	one
Qualification Certificate	one
Remote Control	one



GD400

Explosion Proof Portable Gas Detector



GD400
explosion proof portable
gas detector

GD400 series is a high-performance portable gas detector that can detect multiple gases (Oxygen compounds VOC, combustible gas and toxic gas) at the same time and has man down alarm function. The device has humanized operation functions such as one-key security detection, one-key storage, automatic image flipping, as well as the man down alarm function; With optional Bluetooth transmission function, allowing safety personnel to obtain real-time data and the alarm status. It has obtained international IECEx, ATEX explosion-proof certification and Chinese explosion-proof certification; As it passed the antistatic test, and the protection level reaches IP67; With safer product design and the module design which makes the detection faster, and the compact ergonomic design makes the device easy carrying; What's more, the device is with built in pump, thereby improving the protection to a new Level.

The explosion-proof Grade of the SKY3000 series is Ex ia IIC T4 Ga, which is applicable to the explosive gas mixture zone 0, zone 1, and zone 2 of the factory with grades II A , II B , and II C and temperature group T1~T4.

Specialized in Gas Detection For 16 Years

Product Advantage

Rugged and durable

- The instrument can effectively resist a three-meter drop
- The protection level of the instrument reaches IP67
- The instrument has passed the EMC anti-static interference test and can work normally in the walkie-talkie environment

Explosion-proof circuit design, safe and reliable

- The instrument has got IECEx, ATEX, explosion-proof certificates and the explosion-proof level reaches Exia IICT4 Ga

Multiple security protection

- The man down alarm function has upgraded the safety of underground operators
- Password protection function prevents non-operators from modifying menu parameters
- With safety reminder function, sound and light vibration alarm function, let operators work without worries
- The high and low alarm latched function allows the operator to better capture the sudden change of the gas concentration value

Simultaneous measurement of multiple gases, multiple numerical display

- The instrument can detect 1-5 gases at the same time
- Real-time value, TWA, STEL, MAX, MIN multiple numerical display



Large screen display, flexible detection system, multiple filtering devices

- The screen can be automatically turned 180 degrees, which is convenient for viewing in special operating environments
- Built-in powerful sampling pump, fast detection speed
- Can be connected 20m sampling tube externally, which is convenient for long-distance or confined space detection
- Pump suction use, to provide operators with more reliable protection
- With a water trap filter, it can effectively filter water, oil, dust and other impurities. It can also be used in harsh industrial environments such as coal mines and petroleum fields

Powerful function, more user-friendly operation

- Beautiful and friendly user interface, reasonable and easy-to-use interactive mode
- Optional Bluetooth function, data can be transmitted to the mobile phone or PC in real time
- Standard storage function, one-click data export, convenient for users to analyze
- Unique modifiable ID identification function, convenient for users to allocate and manage the instrument A full range of automatic detection functions, automatic prompts for voltage, pump failure alarms, etc, more comfortable to use One-key security detection one-key open storage, automatic image flip
- Support PPM and mg/m3 gas unit switch, the concentration value is automatically converted by the system Support each channel sensor to restore the factory setting separately
- Support multi-language including English.Chinese and etc.

Product specifications

Sampling method	Pump suction
Gas type	Oxygen, Combustible gas, Carbon monoxide, Hydrogen sulfide, etc different gases as customers' requirements.
Principle	Catalytic combustion, Electrochemistry, IR, PID, etc according to different sensors.
Measure range	O2: 0-30%VOL, EX: 0-100%LEL, CO: 0-1000PPM, H2S: 0-100PPM,etc different measure ranges as customers' requirements.
Resolution	O2: 0.1%VOL, EX: 1%LEL, CO: 1PPM, H2S: 0.1PPM, etc different resolutions according to measure ranges.
Response time	≤30 seconds
Precisiion	≤±2%F.S except for special gases
Language	Chinese/English/Russian (More language can be customized)
Automatically test and calibrate after power-on	Including reset, maximum value (MAX), minimum value (MIN), STEL, TWA value
Unit	PPM and mg/m3 can be switched and displayed by one key, and the concentration value is automatically converted by the system
Disaply	monochrome graphics (160 x96) ,screen can be automatically flipped
Backlight	The backlight time can be manually set, and will be turned on automaticall when y an alarm is issued
Data record	Can store 100,000 sets data, the storage interval is adjustable from 5 to 3600 seconds, data can be exported, with data cable
Alarm	95dB buzzer (@30cm), vibration alarm and flashing red LED and alarm status indication on the screen, alarm latched; diagnostic alarm and battery undervoltage alarm, pump block alarm; man down alarm, with early warning and optional real-time remote Bluetooth comnotification function

Battery	3.7V rechargeable lithium battery, battery capacity 2200mA
Working hours	More than 30 hours in continuous pumping mode
Charger	Travel charger with DC interface, charging time < 4 hours
Explosion-proof grade	IECEX: Ex ia IIC T4 Ga ATEX:  I G Ex ia IIC T4 Ga
Certification (EU regulations)	2004/34/UE (ATEX)
Protection grade	IP67
Working temperature	-20°C~+50°C
Humidity	0 ~ 95%RH (no condensation)
Environmental pressure	86 ~ 106Kpa
Size	157*84.5*59.5mm (including back clip/water trap filter) (length * width * height)
Weight	365g (including battery, belt clip and filter)

Normal gas types and paramaters (Other gases are not listed can be customized)

Detected gas	measure range	Optional ranges	Resolution	Response time
Flammable gas (EX)	0-100%LEL	0-100%VOL	0.1%LEL/0.1%VOL	≤10S
Oxygen (O2)	0-30%VOL	0-25%VOL	0.01%VOL/0.1%VOL	≤10S
Carbon monoxide (CO)	0-1000ppm	0-2000ppm	0.1ppm/1ppm	≤10S
Hydrogen sulfide (H2S)	0-100ppm	0-1000ppm	0.01ppm/0.1ppm	≤10S
Ammonia (NH3)	0-100ppm	0-200ppm	0.01ppm/0.1ppm	≤10S
Chlorine (CL2)	0-10ppm	0-100ppm	0.01ppm/0.1ppm	≤10S
Hydrogen Chloride (HCL)	0-20ppm	0-100ppm	0.01ppm/0.1ppm	≤10S
Nitric oxide (NO)	0-100ppm	0-250ppm	0.01ppm/0.1ppm	≤10S
Nitrogen dioxide (NO2)	0-20ppm	0-100ppm	0.01ppm/0.1ppm	≤10S
formaldehyde (CH2O)	0-10ppm	0-50ppm	0.01ppm/0.1ppm	≤10S
Ozone (O3)	0-10ppm	0-100ppm	0.01ppm/0.1ppm	≤10S
Carbon dioxide (CO2)	0-2000ppm	0-100%VOL	1ppm/0.01%VOL	≤10S

Product configuration

Standard accessories :

- Gas detector 1 piece
- 12V/1A DC power adapter 1
- piece USB cable 1 piece
- User manual 1 piece
- warranty card 1 piece
- Filter 1 piece
- Aluminum suitcase 1 piece



Application



▲ Petrochemical & Chemical Industry



▲ Municipal Engineering & Utilities



▲ Agricultural & Environmental Protection



▲ Electronic



▲ Food & Pharmaceutical Industry



▲ Other Industries

Project Cases



◀ GD400
used in coal mines

▼ GD400
used in sewers and
underground areas



▶ GD400
applied in Oil & Gas industries like
Shell or Petros

▼ GD400
applied in confined spaces like
warehouse, ships, factories,ect.



More Application

- Furniture, Floor, Wallpaper, Coating, Gardening, Interior Decoration and Renovation, Dyestuff, Papermaking, Pharmacy, Health Care, Foodstuff, Antiseptic.
- Disinfection, Chemical Fertilizer, Resin, Adhesive, Pesticide, Raw Material, Sample, Technological Process, Livestock Farm, Refuse Processing Plant, Perm Place.
- Bio-pharmaceutical Plant, Green Household, Livestock Breeding, Green House Cultivating, Warehouse Logistics, Brewing And Fermentation, Agricultural Production.

GD400 Series Gas Detector User Manual



ACCURATE • RAPID • RELIABLE

PLEASE READ CAREFULLY BEFORE USING

Anyone who may use, maintain or repair the instrument should read this operating manual carefully and only follow the operating manual to achieve the design level. Otherwise the instrument will not work properly and will cause malfunction and damage to the instrument.

Warning:

- ▲ The readings beyond the range indicate the concentration of the gas that may or will soon reach the explosion concentration or the concentration of casualties.
- ▲ Replacing components can affect the intrinsic safety of the instrument.
- ▲ It is strictly forbidden to charge the meter in a hazardous area. Users must use the special charger equipped with this unit.
- ▲ Do not disassemble, recharge or replace batteries in hazardous locations. ▲ Charging must be turned off; the instrument must not be operated while charging or exporting data.
- ▲ Portable products, before entering the danger zone, doing electrostatic release of human body, and then carries the instrument into the zone.
- ▲ Do not use the computer's USB interface for communication in hazardous areas. ▲ Old and new batteries or batteries from different manufacturers cannot be mixed.

Attentions :

To ensure maximum safety and performance, please read and follow the items and conditions listed below.

- The air intake of the sensor must be kept clean. Blocking the sensor's air intake may result in readings that are lower than the actual gas concentration .

It is strictly forbidden to use compressed air to clean the air inlet of the sensor to avoid damage to the sensor.

- Catalytic Principle Flammable Gas Sensor and Infrared Principle Sensor can only accurately monitor designated gases. It should be noted, however, that the catalytic principle flammable sensor is not specific to a particular gas and will be able to react to other flammable gases.

- If the instrument is subject to physical impact or high pollution, the calibration cycle needs to be shortened.
- The sensitivity of flammable gas sensors will be affected by high concentrations of sulfides, halogen compounds, silicon-containing compounds, and gases containing "mercury" and "lead", steam, and high temperature organic acid gases. Avoid using them in environments containing the above chemicals. The instrument, if necessary, must be tested and calibrated after use to avoid affecting the accuracy of the instrument.
- The instrument is strictly prohibited from being used in a high concentration of flammable gas for a long time to avoid damage to the flammable sensor. If it is necessary, the instrument should be tested and calibrated after use to avoid affecting the accuracy of the instrument. If the flammable sensor is damaged, it needs to be replaced with a new one. The new sensor can only be reused after it has been calibrated.

- Do not use organic solvents, soap or silicon-containing solutions to clean the instrument to avoid damaging the sensor.
- When sampling with a sampling tube, do not use a sampling tube made of silicone material or other sampling tubes that are not certified by the special source.
- A sudden change in air pressure or a blocked air circuit may cause temporary fluctuations in the instrument's oxygen readings.
 - Large changes in pressure will result in incorrect readings. If the measured gas pressure is greater than 10% of the atmospheric pressure, it will affect the instrument reading and even damage the sensor. The instrument should be re-calibrated and the measured gas should be depressurized.
- It is forbidden to artificially use the gas shock sensor that exceeds the range of the instrument.

If the over-range high-concentration gas impact occurs, the instrument must be re-calibrated.

- When replacing any one of the sensors, the instrument needs to be calibrated.
- Standard gas should be selected from the manufacturer or the nationally qualified enterprise.
- The calibration should be in a well ventilated environment to avoid contamination.
- It is strictly forbidden to calibrate the instrument under the condition of insufficient power supply.
- Do not use the instrument in an oxygen-rich environment.
- It is strictly forbidden to replace the components or structures that affect the explosion-proof

performance at will, so as not to affect the explosion-proof performance.

- It is forbidden to expose the instrument to high concentration acid and alkali gas to avoid damage to the sensor.
 - It is strictly forbidden for users to repair or replace parts without authorization.
 - A sudden change in temperature can cause the output signal of the infrared sensor to be abnormal. After the transient is removed, the instrument will resume normal operation and the ambient temperature change rate should be limited to 2 ° C / min.
- If the gas sample flow rate changes excessively, it will also cause the infrared sensor output signal to be abnormal. After the transients are removed, the instrument will resume normal operation and the gas flow rate should be kept below 0.6 L/min.
- It is strictly forbidden to expose the infrared sensor to corrosive gas such as hydrogen sulfide. It is strictly forbidden to cause condensation inside the sensor.
- Condensation phenomenon inside sensor is strictly prohibited.

Calibration Warning:

- Gas detection equipment is a safe life-saving measuring instrument. To ensure metering accuracy, toxic and catalytic principles flammable gas sensors should be calibrated at least once every six months, while infrared sensors should be calibrated once a year.
 - The gas detector needs to be carefully tested or calibrated after an alarm occurs.
 - This instrument has the function of recording and querying the calibration date. Please check it frequently. Not only do users need to understand the parameters of the instrument, but they also need to understand the meaning of the test data obtained.

Contents

1, Overview	7
2, Product series and models	7
3, Product characteristic	7
4, Product description	7
5, Product configuration	8
6, Technical specifications	8
7, Battery charge	9
8, Operation procedures	10
9, Power on/off	11
9.1 Power on	11
9.2 Power off	12
10, User interface	13
10.1 Detection interface	13
10.2 Status Indicator/Icon	13
11, Operation overview	14
11.1 Alarm function checking	14
11.2 Information checking	14
11.3 Menu	15
12, Function	15
12.1 Fresh air/zero calibration	15
12.2 Span calibration	16
12.3 Calibration interval	18
13, Alarm setting	18
13.1 Alarm limit	18
13.2 Alarm mode	19
13.3 Alarm latched	20
13.4 Man down alarm	21
13.4.1 Turn on/off man down alarm	21
13.4.2 Motion less Time	21
13.4.3 Sensitivity	21
13.4.4 Warning time	21
13.5 Comfort beep	22
13.5.1 On/off	22
13.5.2 Time	22
14, Datalog	22
14.1 Storage on/off	22
14.2 Storage interval	23
14.3 Data type	23
14.4 Data view	23
14.5 Data disk	24
14.6 Full option	25
14.7 Clear record	25
15, Monitor set	25
15.1 Pump on/off	25
15.2 Unit	26
15.3 Date and time set	26

15.4 Language	26
15.5 Display set	26
15.5.1 Brightness	26
15.5.2 Auto brightness	27
15.5.3 Screen rotation	27
15.5.4 Sleep mode set	27
15.6 Security and Privacy	28
15.6.1 Modify Password	28
15.6.2 Site ID and User ID	28
15.7 Self-test	28
15.8 Reset	29
15.8.1 Reset Sensor	29
15.8.2 Reset device	29
15.9 Bluetooth	29
16, About	30
16.1 Monitor Information	30
16.2 Sensor information	30
16.3 Calibration record	30
17, Common faults and solutions	31
18, Terms of Service	32
18.1 Warranty Commitment	32
18.2 Fault repair time	32
18.3 Limited liability guarantee	32
19, Technical support and manufacturer	33



1、 Overview

GD400(volatile organic compounds , combustible gas and toxic gas) at the same time and has man down alarm function. The device has humanized operation functions such as one-key security detection, one-key storage, automatic image flipping, as well as the man down alarm function. With optional Bluetooth transmission function, allowing safety personnel to obtain real-time data and the alarm status, it has obtained international IECEX, ATEX explosion-proof certification and Chinese explosion-proof certification; As it passed the antistatic test, and the protection level reaches IP67; With safer product design and the module design which makes the detection faster, and the compact ergonomic design makes the device easy carrying.

The explosion-proof grade of the GD400 series is Ex d ia IIC T4 Ga, which is applicable to the explosive gas mixture zone 0, zone 1, and zone 2 of the factory with grades IIA, IIB, and ITC and temperature group T1~T4.

2、 Product series and models

The SKY3000 series includes:

1. GD400(regular 4-in-1)
2. GD400-M (single gas)
3. GD400-M2 (two composite gases)
3. GD400-M3 {three composite gases)
4. GD400-M4 (unconventional 4-in-1 gas)

3、 Product characteristic

Rugged and durable

The instrument can effectively resist a three-meter drop.

The protection level of the instrument reaches IP67.

The instrument has passed the EMC anti-static interference test and can work normally in the walkie-talkie environment.

Explosion-proof circuit design, safe and reliable The instrument has got IECEx, ATEX, Chinese explosion-proof certificates and the explosion-proof level reaches Ex d ia IIC T4 Ga

Multiple security protection.

The man down alarm function has upgraded the safety of underground operators.

Password protection function prevents non-operators from modifying menu parameters.

With safety reminder function, sound and light vibration alarm function, let operators work without worries.

The high and low alarm latched function allows the operator to better capture the sudden change of the gas concentration value.

Simultaneous measurement of multiple gases, multiple numerical display

The instrument can detect 1-5 gases at the same time.

Real-time value, TWA, STEL, MAX, MIN multiple numerical display.

Large screen display, flexible detection system, multiple filtering devices

The screen can be automatically turned 180 degrees, which is convenient for viewing in special operating environments.

Built-in powerful sampling pump, fast detection speed.

Can be connected 20m sampling tube externally, which is convenient for long-distance or confined space detection.

With a water trap filter, it can effectively filter water, oil, dust and other impurities. It can also be used in harsh industrial environments , such as coal mines and petroleum fields.

Powerful function, more user-friendly operation

Beautiful and friendly user interface, reasonable and easy-to-use interactive mode.

Optional Bluetooth function, data can be transmitted to the mobile phone or PC in real time.

Standard storage function, one-click data export, convenient for users to analyze.

Unique modifiable ID identification function, convenient for users to allocate and manage the instrument.

A full range of automatic detection functions, automatic prompts for voltage, pump failure alarms, etc., more comfortable to use One-key security detection, one-key open storage, automatic image flip.

Support PPM and mg/m3 gas unit switch, the concentration value is automatically converted by the system.

Support each channel sensor to restore the factory setting separately.

Support multi-Language including English , Chinese and etc.

4、 Product description

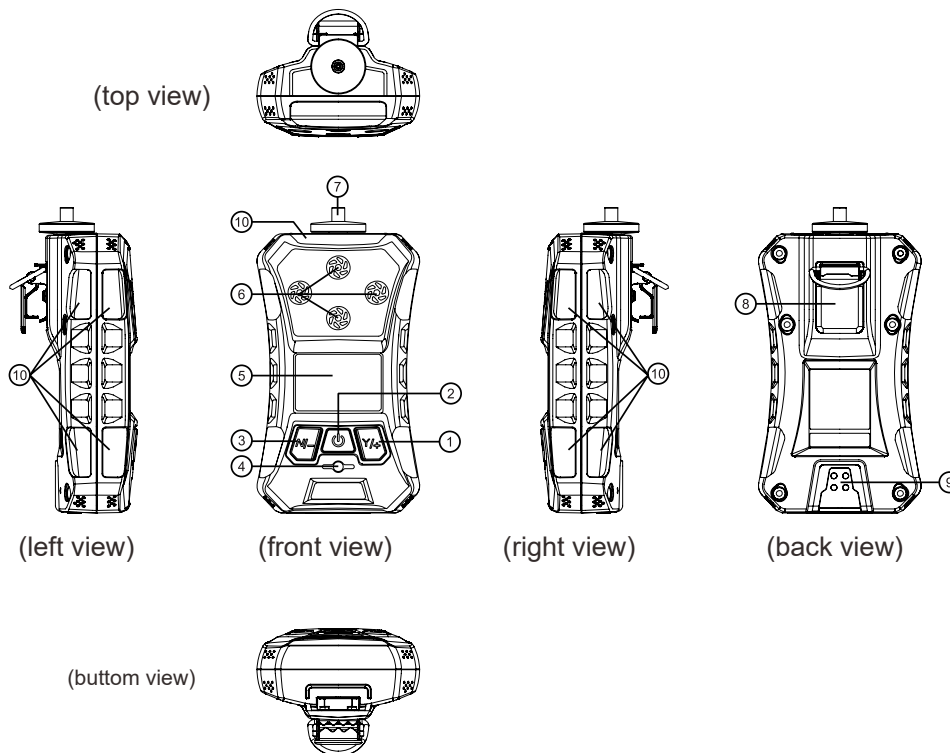

①	Y+key	⑥	Gas outlet
②	Mode key	⑦	Gas inlet
③	N-key	⑧	Belt clip
④	Buzzer	⑨	Charging and communication contact
⑤	Display	⑩	Alarm light

① [Y/+] key, Long press to turn on or off the datalog function (main interface); confirm entry/switch (menu interface); Numerical increase (need to enter the numerical interface); stop (calibration countdown interface).

② [MODE] key, Long press to power On/off (any interface): Exit (menu interface) Confirm (need to enter the numerical interface).

③ [N/-] key, Long press to enter the main menu (the display interface enters the menu interface); move down or right options (menu interface).

- Buzzer: Voice prompt and alarm function.
- Display, Display gas concentration and various parameters.
- Sensor, Measure gas concentration.
- Filter, Gas inlet.
- Belt clip, Stainless steel material, auxiliary fixing entrainment instrument.
- Charging and communication contact: Connect the charging stand to charge the instrument / transmit data to the PC.

⑩ LED light, Light alarm function.

5、 Product configuration

1, Standard accessories :

- (1) Gas detector 1 piece
- (2) 12V/1A DC power adapter 1 piece
- (3) Charge base 1 piece
- (4) USB cable 1 piece
- (5) User manual 1 piece
- (6) warranty card 1 piece
- (7) Filter 1 piece
- (8) Aluminum suitcase 1 Piece
- (9) 1 rubber stopper (please install the rubber stopper in time after charging/data transfer is completed.)

6、 Product specifications

Sampling method	pump suction type
Response time	CO、 O2、 EX<30 seconds, H2S<60 seconds
Language	Chinese/English (more language can be customized)
Automatically test and calibrate after power-on	Including reset,maximum value (MAX), minimum value (MIN), STEL, TWA value
Unit	μmol/mol、 mg/m ³ 、 PPM can be swiftd

Display	monochrome graphics (160x96) ,screen can be automatically flipped
Backlight	The backlight time can be manually set, and will be turned on automatically when an alarm is issued
Data record	Can store 100,000 sets data, the storage interval is adjustable from 5 to 3600 seconds, data can be exported, with data cable
Alarm	95dB buzzer (@30cm), vibration alarm and flashing red LED and alarm status indication on the screen, alarm latched; diagnostic alarm and battery undervoltage alarm, pump block alarm; man down alarm, with early warning and optional real-time remote Bluetooth
Battery	3.7V rechargeable lithium battery
Working hours	More than 15 hours in continuous pumping mode
Charger	Travel charger with DC interface, charging time = 4 hours
Explosion-proof grade	IECEX:Ex da ia IIC T4 Ga(with EX sensor),Ex ia IIC T4 Ga(without EX sensor) ATEX: Ex II 1G Ex da ia IIC T4 Ga, Ex II 1G Ex ia IIC T4 Ga
Certification (EU Regulation)	2014/34/EU(ATEX)
Protection grade	IP67
Working temperature	-20°C~+50°C
Humidity	0~90%RH (no condensation)
Environmental pressure	86~106Kpa
Size	157*84.5*59.5mm (including back clip/water trap filter) (length• width • height)
Weight	365g(including battery, belt clip and filter)

7、 Battery charging

The detector is equipped with special charging equipment, and the charging process is shown in the figure below.

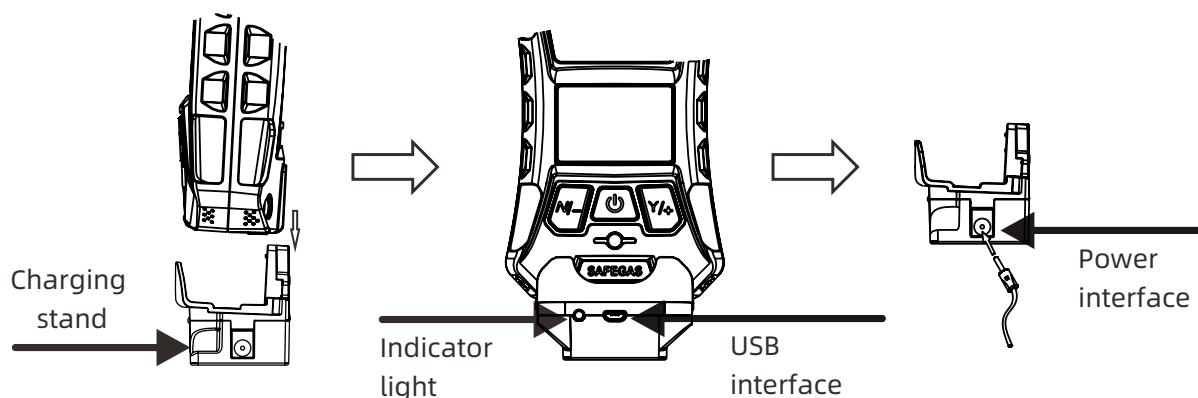

- 1、 First, insert the charging/ communication contact into the charging stand to ensure that the detector is tightly engaged with the charger stand
- 2、 Then insert the round plug of the power adapter into the jack on one side of the charger stand, and plug the other end of the power adapter into the power source.
- 3、 The detector is charged after connecting with power source, the LED indicator is red, and the display shows the charging status. After the battery is fully charged, the display shows that the battery is fully charged which means the charging is complete.

Note

1. It is forbidden to charge the detector in non-safe areas.
2. Please do not violently plug or unplug the detector and charging equipment.
3. Before charging, check whether there is dirt on the contacts and probes, whether the contacts on the back of the detector are in good contact with the probes of charging the stand, and whether the bite is in place.

8、 Operation process

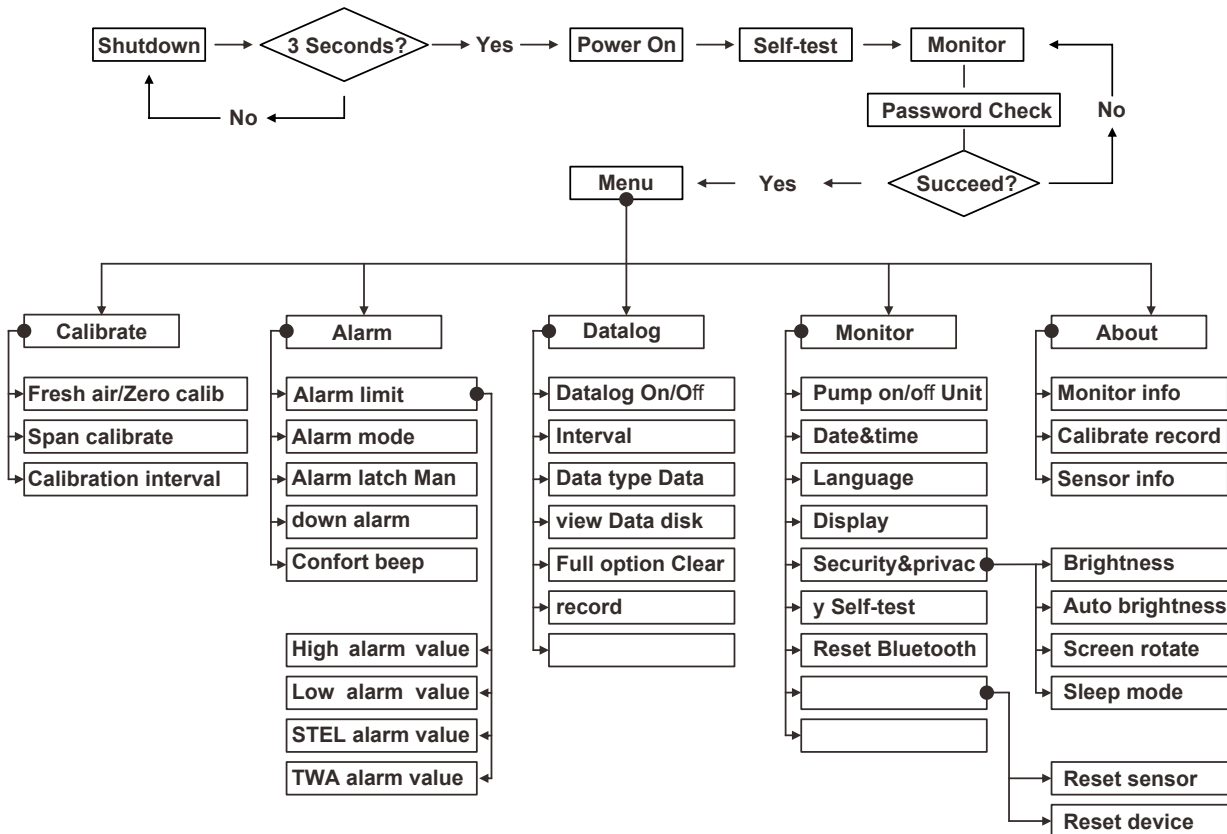

9、Power on/off

9.1 Power on

When the detector is off, press and hold the [MODE] key, the backlight will light up, and a countdown progress bar will appear on the screen. Release the [MODE] key after the countdown complete. Then the detector starts, the backlight, alarm light and vibration turn on. SAFEGAS mark will appear on the screen, and then enter the self-check interface.

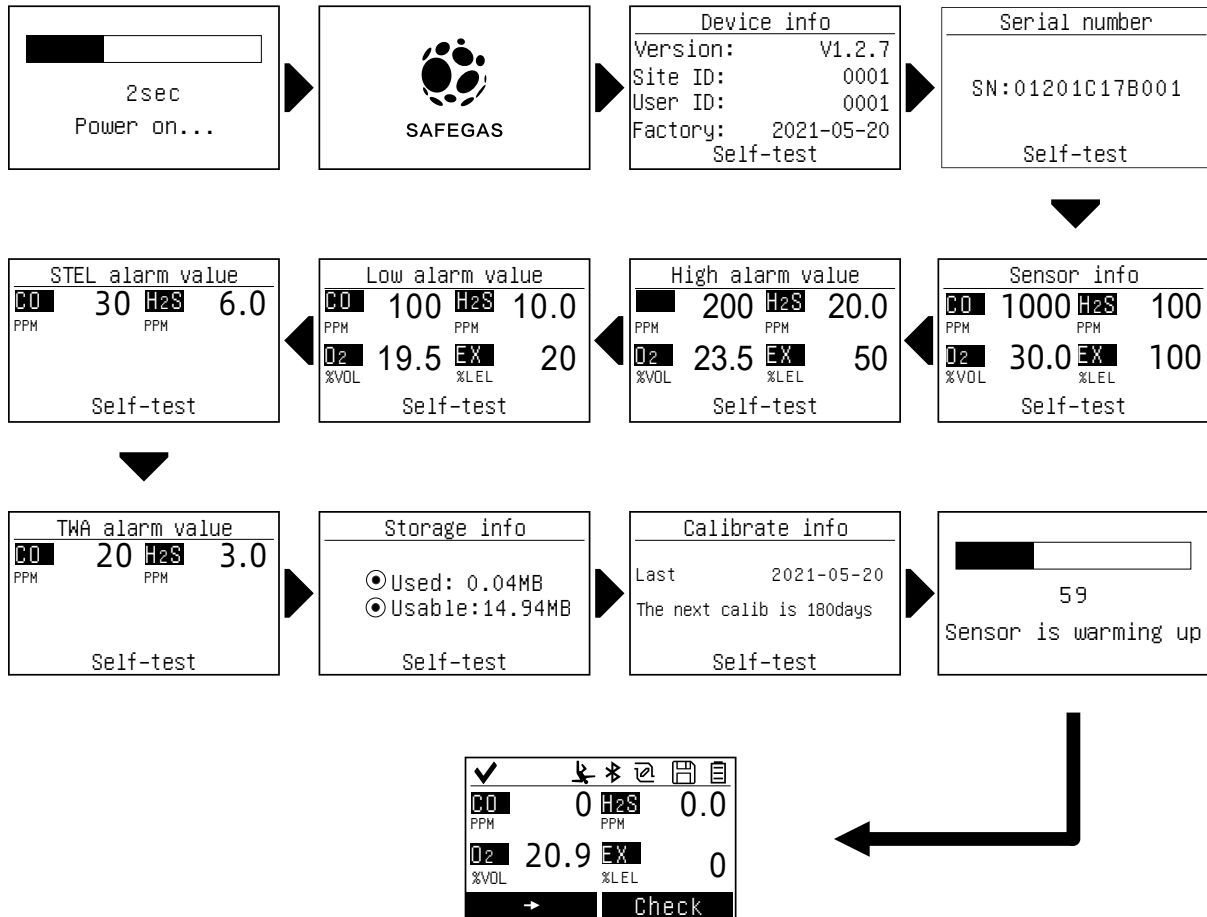

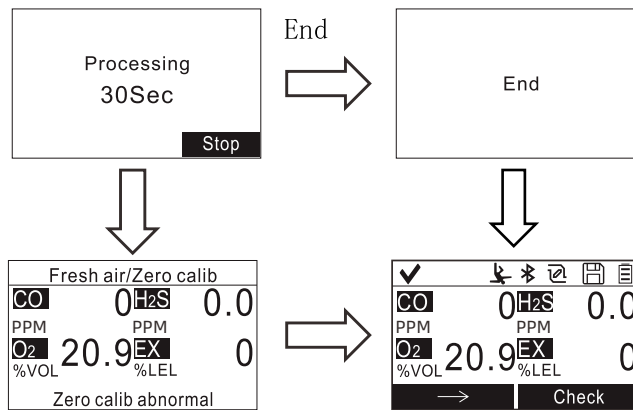

The normal start up of the detector will gradually display the following steps, showing the current settings of the instrument:

1. Equipment information: version, site ID, user ID, manufacture date
2. Serial no
3. Sensor information
4. High alarm value
5. Low alarm value
6. STEL
7. TWA
8. Data log information
9. Calibration information

After loading the self-test interface, it will enter the sensor preheating interface, and there will also be a countdown action. This action takes about 1-2 minutes. After the countdown, the display interface will prompt whether the detector is performing fresh air/zero calibration.

During the calibration, a 10-second countdown will be displayed, and the calibration can also be terminated during the process. Once the calibration is completed, it will formally enter the detection interface and the detector is successfully turned on.

Note: Please keep the battery fully charged and start the machine in a fresh air environment. If you can't start the machine to eliminate the above problems, please contact sales for consultation.

9.2 Power Off

Press and hold [MODE] . A 5-second countdown to shutoff begins. You must hold your finger on the key for the entire shutoff process until the device is powered off.



Device info	
Gas	CO/H2S/O2/EX
Range	1000/100/30/100
Power	100%
Site ID	0001
User ID	0001

In the Shutdown state, long press [N/-] key for 3 seconds to briefly display the following device information

1. Gas type
2. Measure range
3. Power
4. User ID
5. Site ID

Note: Please turn off the device after the reading drops to zero in clean air (except for oxygen, nitrogen and carbon dioxide)





10、 User Interface

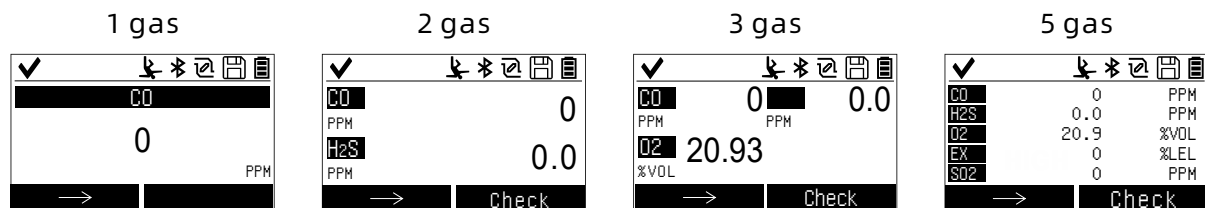
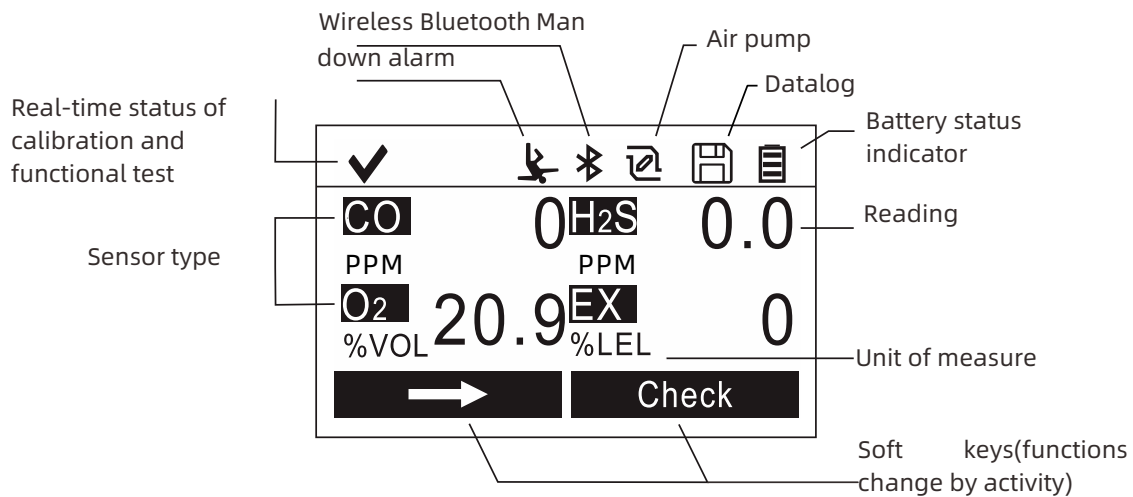

10.1 Detection interface

The LCD display provides visual feedback that includes the sensor types, readings, battery condition, and other functions.



10.2 Status Indicator Icon

Icon	function
	Bluetooth function(This is an optional function, shown when bluetooth is on,blank when off) Pump
	on status
	Pump off status
	Storage function (Shown when storage is on, blank when off)
	Power (three segments show battery charge level)

	Man down alarm function (Show when man down alarm is on, blank when off)
	Self-test passed
	Self-test failed

11、 Operation overview

11.1 Alarm function checking

On detection interface, press [Y/+] key to test whether the buzzer, vibration alarm, LED indicator and backlight function are in good condition. The following interface shows when the buzzer is off.



Note: The premise for the one-key check function to take effect is in normal mode and non-alarm state.

11.2 Information checking

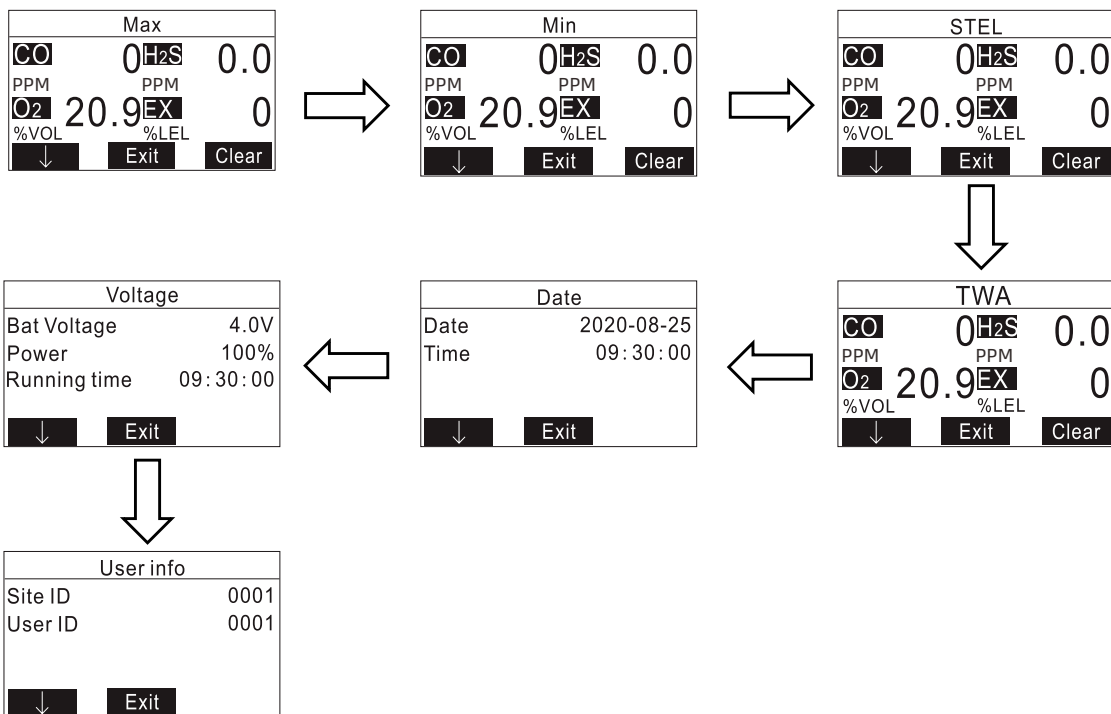

On detection interface, press the [N/-] key to display the following interfaces in sequence.

1. Max value
2. Min value
3. STEL value
4. TWA value
5. Date and time
6. Batter voltage, power, running time
7. User information: Site ID, user ID

When the device is in the above information interface, press the [MODE] key can back to the detection interface, press the [Y/+] key to clear. After all the information interfaces are displayed, press the [N/-] key to return to the detection interface.

11.3 Menu

To enter main menu interface, press and hold [N/-] key for 3 seconds until you see the Password screen.

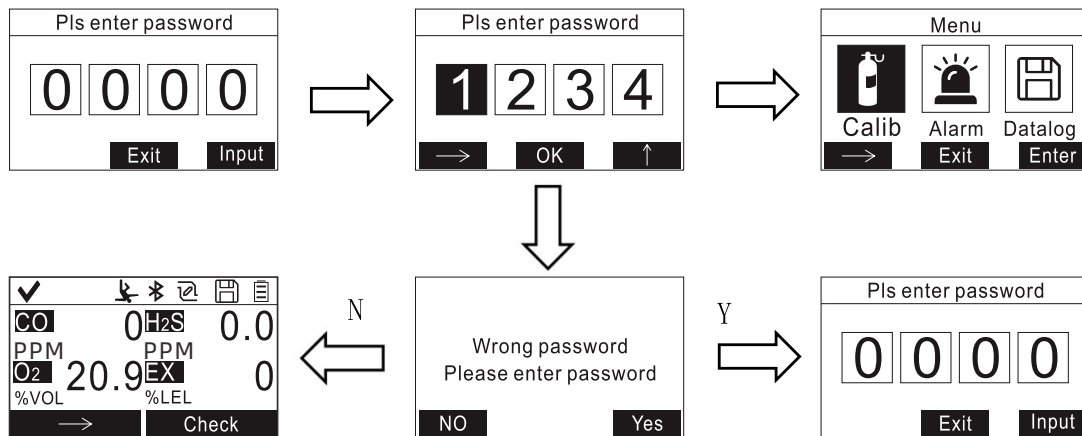

Input the 4-digit: password

- Increase the number from 0 through 9 by pressing [Y/+].
- Step from digit to digit by using [N/-] .
- Press [MODE] when you are done.
- If you make a mistake, you can cycle through the digits by pressing [N/-] and then using [Y/+] to change the number in each position.
 - If you input the correct password, you will enter the main menu. If you input the wrong password, you will enter the mistake prompt interface. Press [N/-] key and select No to back to display interface. Press [Y/+] key to back to password screen.

Note: The default password is 1234. The password screen only appears when you enter the main menu at the first time. If you have input the correct password, you do not have to input it again to enter main menu until you turn the device off and on again.

12、Functions

12.1 Fresh Air/ Zero Calibration

At the Calibration menu, press [N/-] key to select the sensor and then start the calibration by pressing [Y/+] , then there is a 30 seconds of countdown, the device will send a buzzer sound. The calibration is done when the screen shows you a Succeed.

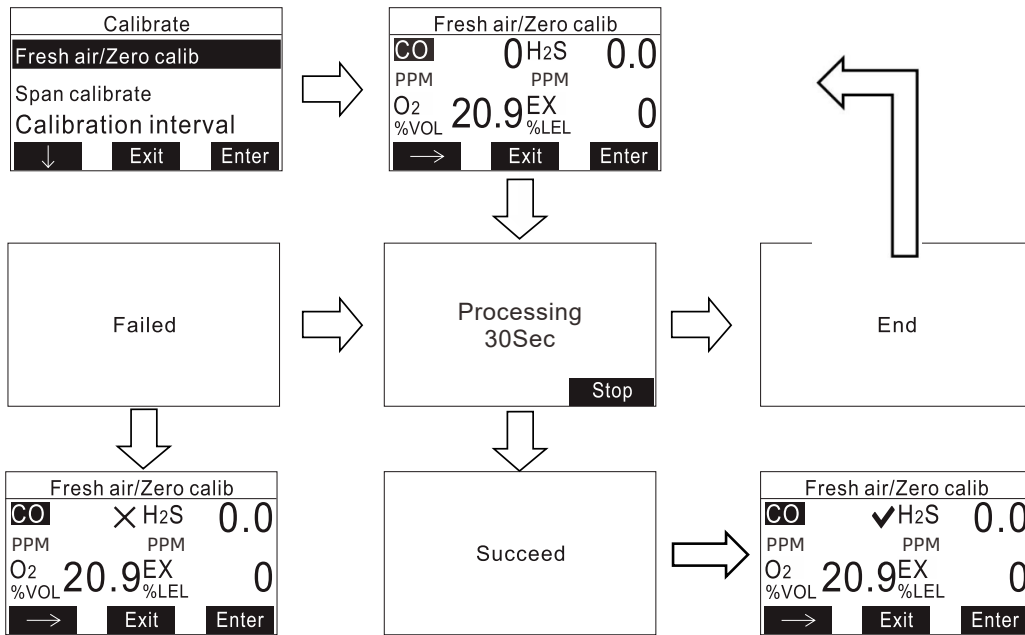

You can terminate the calibration at any time during the countdown by pressing [Y/+]. If the calibration is succeed, it will show av beside the calibrated gas, if the calibration is failed, it will show √ beside the calibrated gas.

- Note:
1. Sensor should be calibrated in the dry air with 20.9% of oxygen and no impurities.
 2. The zero point calibration should be done before the span calibration.

12.2 Span Calibration

GD400 draws in air at a flow rate of between 450mL/min - 650mL/min. When calibration, the device must be connected to a standard gas cylinder through a T-shaped calibration tube (three-way connector), and the other end is connected to a flow meter. During ventilation calibration, ensure that the evacuation of the flow meter is above 100mL/min.

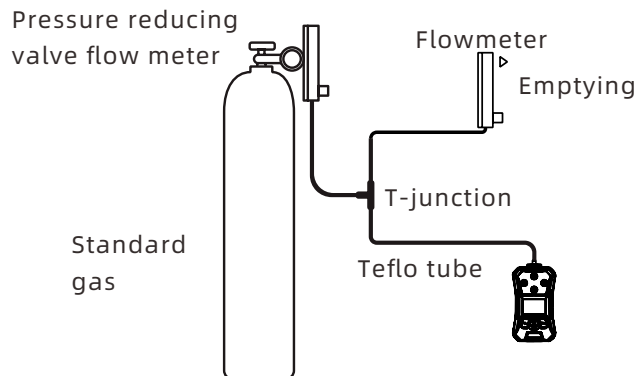

- Press [N/-] to select the gas, then press [Y/+] to enter selected gas calibration screen.

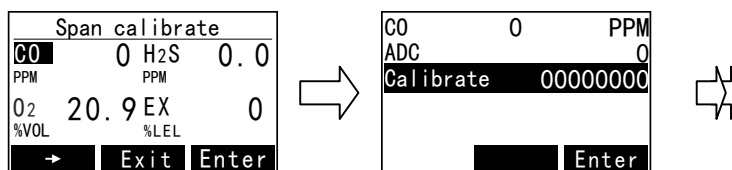

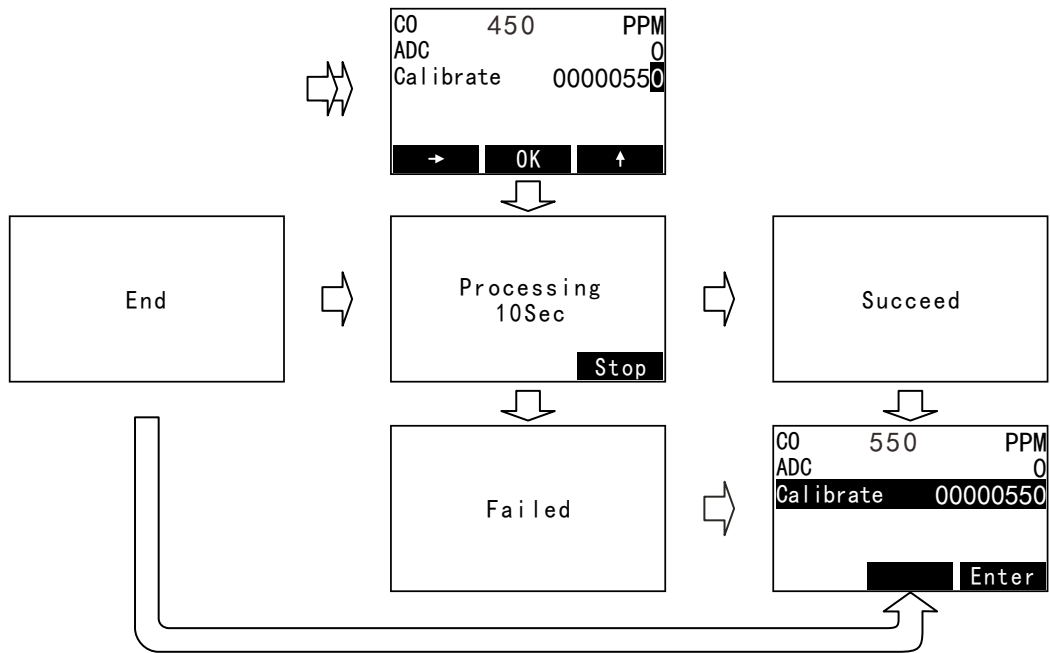

There is a calibrate in the span calibration sub-interface, and the right side is the calibration setting value. The upper part displays the current gas type, real-time concentration value, unit and ADC value.

The span calibration procedure is as follows (the following example assumes a standard gas of 550 ppm CO):

- After the detector is turned on and enters the detection interface, connect the standard gas of known concentration to the gas inlet of the detector through the PTFE tube.
- Enter the span calibration interface, press the [N/-] key to select the gas channel, and press the [Y/+] key to enter the “span Calibration ” submenu.
- Press - the [Y/+] key to enter the parameter setting mode, and modify the value (set value 550) on the right to the standard gas concentration used.
- Open the standard gas valve, and input the target CO standard gas to the detector at a flow rate of 500mL/min (ml/min), until the real-time concentration displayed by the detector (the upper middle) is basically stable (about 1-3 minutes, different sensors the stabilization time is different), press the button, the detector will enter the 30-second countdown, after the countdown, the detector will have a buzzer sound, and the screen will show succeed to tell you the span calibration is completed.

Note:

1. During the calibration countdown period, you can press the [Y /+] key to terminate the span calibration.
2. Before the span calibration, please confirm that the standard gas tube has been well connected. Only starts the span calibration after the displayed value is stable, otherwise the reading will be inaccurate.
3. Setting value: input the concentration of the standard gas.
4. When selecting the calibration point, please follow the principle of zero point value < calibration value < full range value, otherwise calibration will fail.

12.3 Calibration interval

It is used to remind the user that the device needs to be re-calibrated. The factory default calibration interval is 180 days (the setting range is 0-360 days). If the calibration expires, it will remind the user that the device needs to be re-calibrated when you power on.

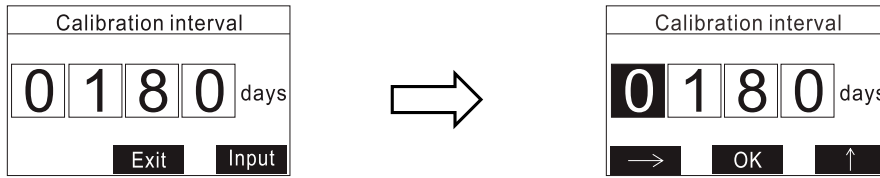

Calibration interval setting,

- Press [Y/+] to change the number.
- Press [N/-] to move digit.
- Press [MODE] to complete.

13、Alarm setting

13.1 Alarm limit

There are 4 alarm settings for every type of gas as following:

- High alarm value (High alarm point)
- Low alarm value (Low alarm point)
- STEL value (Short-term exposure limit)
- TWA value (Weighted average)

Take setting the high alarm limit as an example, press the [Y/+] key on the alarm limit setting interface to enter the high alarm limit interface.

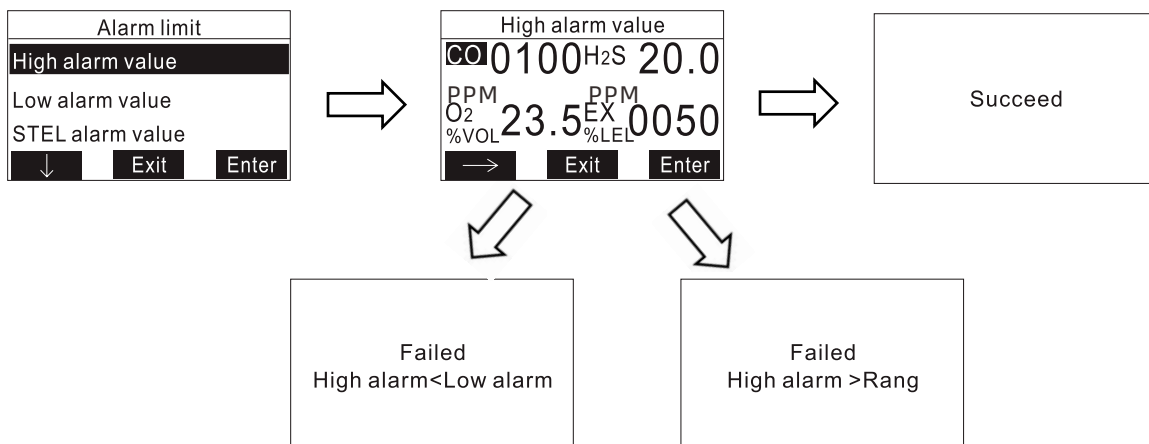

High alarm limit setting,

- Press [Y/+] to change the number.
- Press [N/-] to move digit.
- Press [MODE] to complete.

Evaluation using the short-term exposure tolerable concentration (PC-STEL) standard

The test result is the 15min time-weighted average concentration of hazardous substances measured at the highest concentration of hazardous substances at the operation site. The calculation method of the 15min time-weighted average concentration is:

(1) When the sampling time is 15min, the time-weighted average concentration of 15min is the test result of the sample, mg/m³.

(2) When the sampling time is less than 15min, when sampling more than once, calculate as follows: $CSTEL = (C_1T_1 + C_2T_2 + \dots + C_nT_n) / 15$
 In the formula: CSTEL-15min time-weighted average concentration, mg/m³; C₁, C₂, C_n-measured concentration of harmful substances in the air, mg/m³; T₁, T₂, T_n - the working time of workers at the corresponding concentration of harmful substances, min.

The time-weighted average allowable concentration (PC-TWA) standard was used to evaluate

The test result is the 8-hour time-weighted average concentration of occupational disease hazard factors in the workplace. The 8-hour time-weighted average concentration is calculated as follows: $CTWA = (C_1T_1 + C_2T_2 + \dots + C_nT_n) / 8$

In the formula: CTWA - 8h time-weighted average concentration of harmful substances in the air, mg/m³;

C₁, C₂, C_n-measured concentration of harmful substances in the air, mg/m³;
 T₁, T₂, T_n - the working time of workers under the corresponding concentration of harmful substances, hour

Use the maximum overrun multiple to evaluate

Many substances with PC-TWA have not yet formulated PC-STEL. For dust and chemicals without PC-STEL, the upper drift limit should be controlled even if their 8h TWA does not exceed PC-TWA. Therefore, the over-limit multiple can be used to control the excessive fluctuation of its short-time exposure level. The concentration corresponding to the exceeding multiple is the short-term exposure concentration, and the sampling and detection methods are the same as those of PC-STEL. For chemically harmful factors for which PC-STEL is not formulated, the concentration of any short-term (15min) exposure should not exceed the multiple of PC-TWA under the condition of the 8h time-weighted average allowable concentration.

Calculation of overrun multiples: Overrun multiple = C_{15min}/PC-TWA

In the formula: C_{15min}—measured short-term harmful substance concentration in the air, mg/m³; PC-TWA—The time-weighted average allowable concentration of the hazardous substance.

Note:

1. The low alarm value can't be higher than the high alarm value.
2. The low alarm value or high alarm value can't be higher than measure range.
3. There is no STEL value and TWA value for oxygen and combustible gas.

13.2 Alarm mode

There are three alarm modes including LED light, buzzer, and vibrator. The user can switch on or off the three mode by pressing the [Y/+] .

Note: The three alarm modes of the device are turned on by default. Do not turn off them unless necessary.

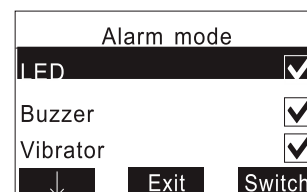

Alarm Signal Summary

Type	State			
	LED	Buzzer	Motor	Disable all
Key tone	noting	Sing 50ms/times	noting	-
Check	On 50ms,off 50ms,5 times	Sing 500ms,stop 500ms, 1 times	On 500ms,off 500ms, 1 times	noting
Low alarm	On 250ms,off 250ms,2 times	Sing 250ms,stop 250ms, 3 times	On 500ms,off 500ms, 1 times	noting
High alarm	On 130ms,off 120ms,4 times	Sing 130ms,stop 120ms, 4 times	On 500ms,off 500ms, 1 times	noting
Warning alarm	On 100ms,off 100ms,5 times	Sing 100ms,stop 100ms, 5 times	noting	-
Man down alarm	On 50ms,off 50ms,10 times	Sing 50ms,stop 50ms, 10 times	noting	-
Low power alarm	noting	Sing 200ms,stop 200ms, 7 times	noting	-

13.3 Alarm latched

There are four mode in Alarm latched

Automatic reset: when the device is restored from the high/low alarm state to the normal state, the device will automatically release the alarm.

Low alarm latched: When the device is restored from the low alarm state to the normal state, it still locks the previous low alarm state, and the alarm lock box pops up every 20 seconds until the alarm is manually released or the automatic reset or high alarm latched option is reset.

High alarm latched: when the devices restored from the high alarm state to the normal state, it still locks the previous high alarm state, and the alarm lock box pops up every 20 seconds until the alarm is manually released or the automatic reset or high alarm latched options reset.

High&Low latched: when the device is restored from the high/low alarm state to the normal state, it still locks the previous high/low alarm state, and the alarm lock box pops up every 20 seconds until the alarm is manually released or the automatic reset, high alarm latched or low alarm latched are reset.

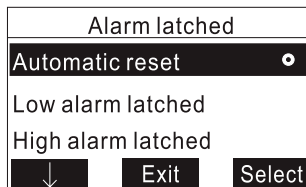

- Press [N/-] to select the alarm mode and press [Y/+] to confirm.

13.4 Mandown alarm

13.4.1 Turn on or off man down alarm

When man down alarm function is turned on, its icon will show on display interface:

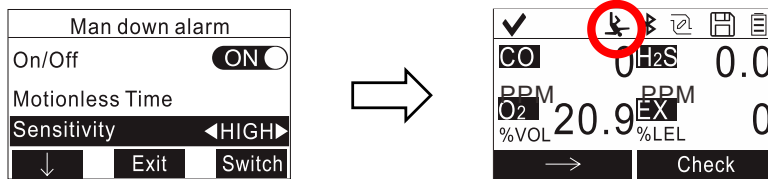

- Press [Y/+] to turn on or off man down alarm.

13.4.2 Motionless Time

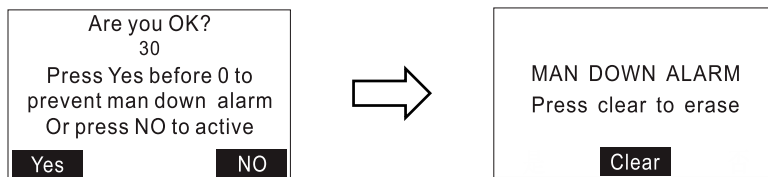

When the Man Down alarm is activated, the device detects that the motionless time exceeds what was set before, if the device still keeps stand, it will send the buzzer sounds at the same time a pre-alarm is activated to alert the user and shows the "Are You OK?" screen. Pressing [N/-] clears the alarm and returns to its normal operation. Press [MODE] to clear man down alarm info.

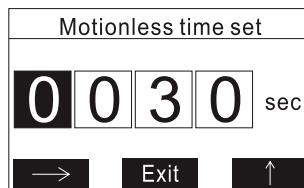

The motionless time can set by user (Range: 30-360 seconds)

- Press [Y/+] to change the number.
- Press [N/-] to move digit.
- Press [MODE] to complete.

13.4.3 Sensitivity

The sensitivity of the man down alarm function refers to the sensitivity of the three-axis sensor. The higher the sensitivity, the smaller the tilt angle of the three-axis sensor, and the less likely it is to activate the man down alarm function. The lower the sensitivity, the easier it is to activate the man down alarm function.

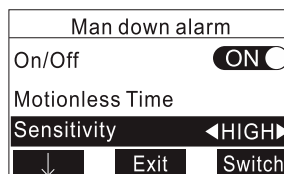

- Press [Y/+] to adjust the sensitivity.

13.4.3 Warning time

The countdown time of the pre-excitation prompt interface can be set (Range: 30-360 seconds).



- Press [Y/+] to change the number.
- Press [N/-] to move digit.
- Press [MODE] to complete.

13.5 Comfort beep

13.5.1 On/Off

Comfort beep is to make a long beep every specified time, reminding the user to be safe. It can be turned on or off.

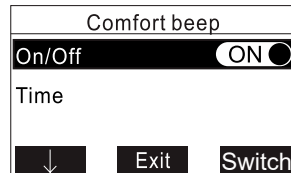

- Press [Y/+] to turn on or off the comfort beep.

13.5.2 Time

The time interval of comfort beep can be set.



- Press [Y/+] to change the number.
- Press [N/-] to move digit.
- Press [MODE] to complete.

Note: Comfort beep will tweet when the following conditions are met:

1. The comfort beep function is turned on.
2. The device is in the gas detection interface.
3. The device is not in battery alarm state.
4. The device is not in alarm state.

14、Datalog

14.1 Storage On/Off

When the storage function is turned on, there is a storage icon displayed in the upper right corner of the detection interface.

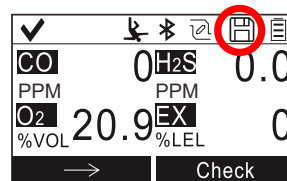
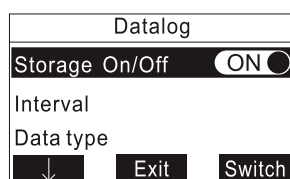

- Press [Y/+] key to turn on or off the data log function.

14.2 Storage interval set

The user can set the storage time interval value, the minimum time interval is 5S.

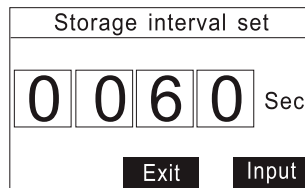

- First press the [Y/+] key to confirm the input, and then continue to press the [Y/+] key to modify the value.
- Press [N/-] to move the cursor.
- After entering the number of seconds, press [MODE] to save and exit.

14.3 Data type

The data types stored by the instrument include real-time data, maximum value, minimum high alarm value, low alarm value and all alarm values. The user can freely choose one of the value, stored data types.

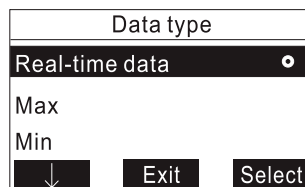

- Press [N/-] to move the cursor, press [Y/+] to select and confirm.

14.4 Data View

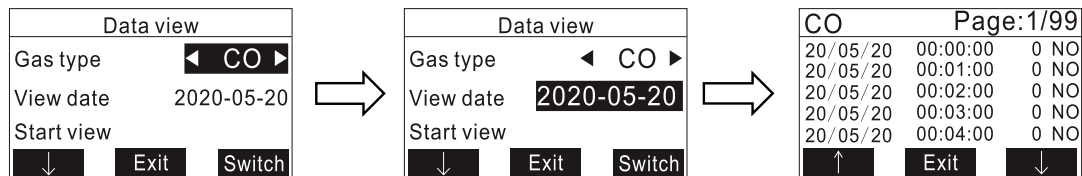

The user can view the corresponding time point and data records of different types of sensors on the instrument through the storage view function.

The specific operations are as follows:

- First press the [Y/+] key to switch the type of gas to be viewed
- Then press the [N/-] key to switch to the date viewing option, and press the [Y/+] key to confirm
- Continue to press [N/-] and [Y/+] to adjust the date
- Finally press the [N/-] key to switch to the start view, press the [MODE] key to confirm the view.

14.5 Data Disk

The user can copy the stored data of the instrument to the computer through this function.

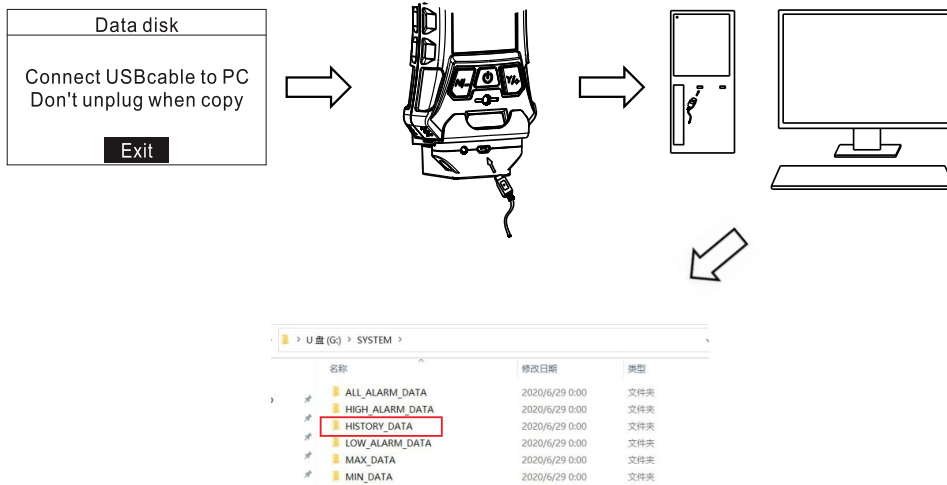

Data export operation:

- Press [Y/+] to confirm and enter the data disk interface
- Connect the instrument to the charging base (same as battery charging operation)
 - Insert one end of the USB data cable into the USB port of the charging stand and the other end into the USB of the computer.
 - Open the "HISTORY-DATA" folder in the "Removable Disk" on the computer.
 - The "2020.06.29.CSV" file is "copy" or "cut" to the computer, and the data copy is completed.

Note:

1. Do not unplug or plug the USB data cable during the data copy process.
2. The instrument should be kept on the data disk interface during the data copy process, and please do not operate the instrument during the copy process.

14.6 Full option

After the data is full, there are two options:

1. Stop when full: stop data storage.
2. Cover history data: loop overwrite the data at the beginning.

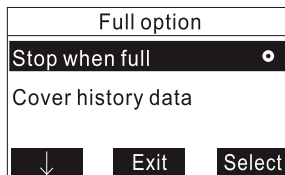

- Press [N/-] to move the cursor, press [Y/+] to select and confirm.

14.7 Clear record

The user can use this function to clear the historical data saved in the instrument.

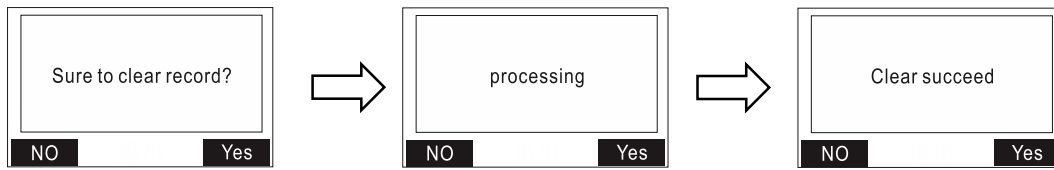

Data clear operation:

- Press [Y/+] to enter the data record clear interface
- Press the [Y/+] key to select "Yes", the interface displays "Processing", and finally displays "Clear succeed" and the operation is complete .

Note:The data cannot be recovered after being cleared, please use this function with caution.

15、Monitor Set

15.1 Pump on/off

When the pump is working normally, the pump status icon at the top of the detection interface will appear alternately:



This icon display represents the pump is off:

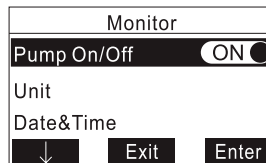

Turn the pump on and off:

Enter the instrument setting menu, press the [Y/+] key to switch to ON/OFF state, or press and hold the [Y/+] key for three seconds on the detection interface.

Note: Do not turn off the pump except in special circumstances.

15.2 Unit

This function is used to change gas unit.

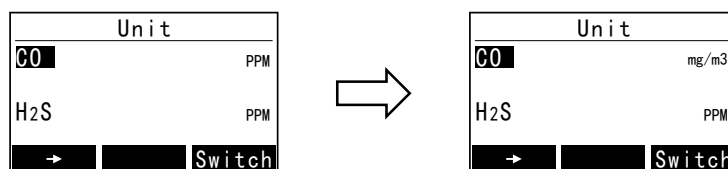

- Press [Y/+] key to switch gas units.

15.3 Date and time set

The date is set to "year/month/day", and the time is set to a 24-hour format system, respectively, "hour : minute : second".

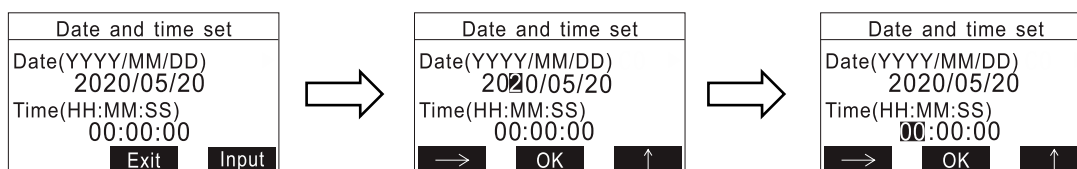

The body setting steps are:

- First press the [Y/+] key to confirm the input, and then continue to press the [Y/+] key to increase to the desired number.
- Press [N/-] to move the cursor.
- After inputting, press [MODE] to confirm.
- If you make a mistake, press the [N/-] key to cycle through the numbers, and then press the [Y/+] key to change the number of each position.

15.4 Language

The instrument has two language options, Chinese and English.



- Press [N/-] to switch options, press [Y/+] to confirm.

Note: Other languages can be customized.

15.5 Display Set

15.5.4 Brightness

The user can manually adjust the brightness of the LCD screen to adapt to some special test environments, such as extreme temperatures and environments with different brightness/darkness.

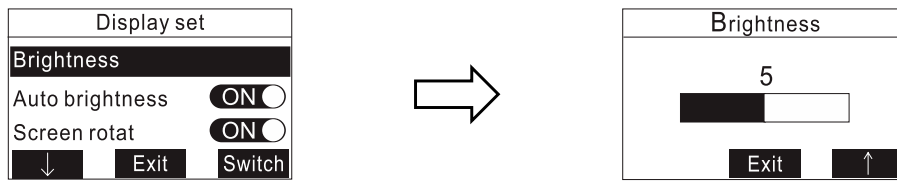

- Press [Y/+] first to enter the brightness setting interface.
- Then press the [Y/+] key to adjust the brightness of the LCD screen.
- Finally press [MODE] to save and exit.

15.5.2 Auto brightness

After turning on, the instrument can automatically adjust the brightness of the LCD screen according to the brightness of the surrounding environment.

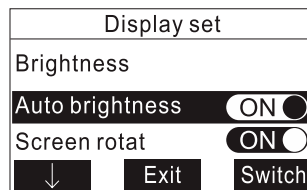

- Press [Y/+] key to turn on or off automatic brightness adjustment.

15.5.3 Screen rotation

In the detection interface, when the state of the instrument is reversed, the vertical/horizontal state sensor of the instrument can automatically rotate the display content by 180° for easy viewing.

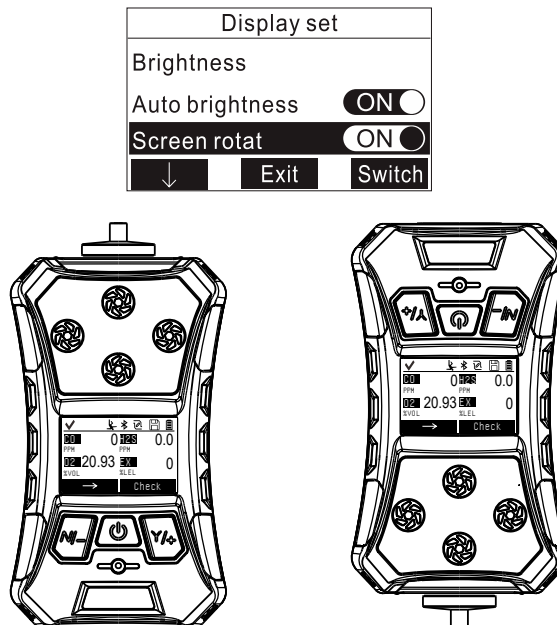

- Press [Y/+] to turn on or off the automatic screen rotation.

15.5.4 Sleep mode set

Sleep mode allows the user to modify the LCD screen on time, the time can be 15 seconds-30 minutes optional, or choose to keep the screen on.

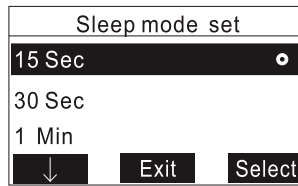

- Press [N/-] to switch options, press [Y/+] to confirm.

14.6 Security and Privacy

14.6.1 Modify Password

To enter the "menu", you need to enter a 4-digit password for verification. The initial password is "1234". The user can modify the verification password through the password modification function.

Password modification settings:

- First press the [Y/+] key to confirm the input, and then continue to press the [Y/+] key to increase the number from 0-9.
- Press and hold the [N/-] key to move the cursor.
- After entering two identical 4-digit passwords, press [MODE] to confirm.

14.6.2 Site ID and User ID

The site ID and user ID number information can be displayed by shortcut keys in the shutdown state, which is used to quickly identify the site and user of the instrument, and the four-digit unit/user number as a specific identification is also part of the data record (Will exist in the export data record table).

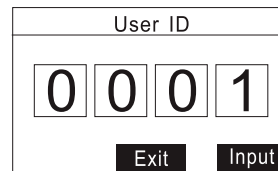
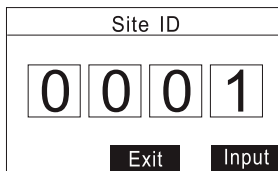

Site ID and user ID settings,

- First press the [Y/+] key to confirm the input, and then continue to press the [Y/+] key to increase the number from 0-9.
- Press [N/-] to move the cursor.
- After entering the 4-digit ID, press [MODE] to save and exit"

14.7 Self-test

The user can set the add-on items for the power-on self-test projects, the add-ons have STEL alarm value, TWA alarm value, Storage info, calibration info.

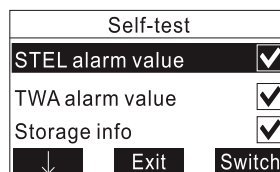

- Press [N/-] to move the cursor, press [Y/+] to switch whether to open the add-in.

14.8 Reset

14.8.1 Reset Sensor

This function can restore the sensor of the instrument to the factory calibration parameters.

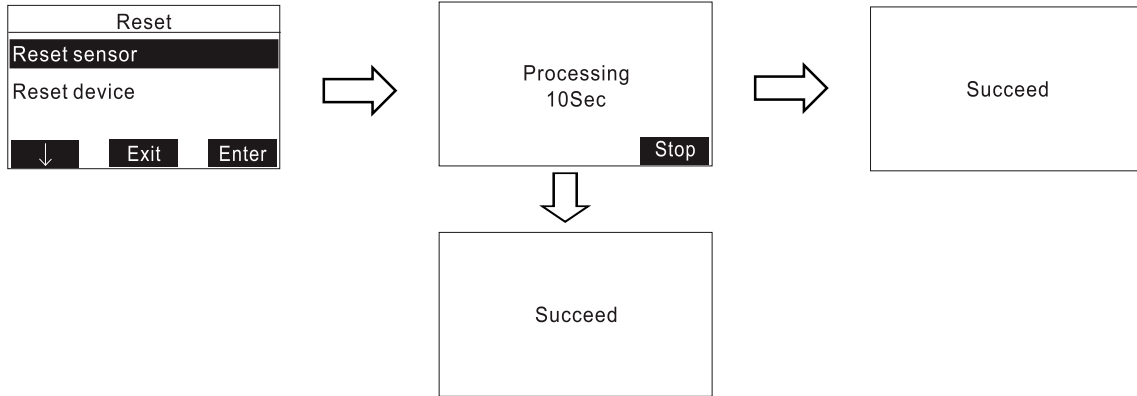

- Press the [Y/+] key to confirm the selection and restore, during which a 10-second countdown will be displayed. During the countdown, press the [Y/+] key again to terminate the restoration setting.

14.8.2 Reset device

This function can restore the settings of the instrument's various parameters (except the sensor calibration parameters) to the factory parameters.

- Press the [Y/+] key to confirm the selection and restore, during which a 10-

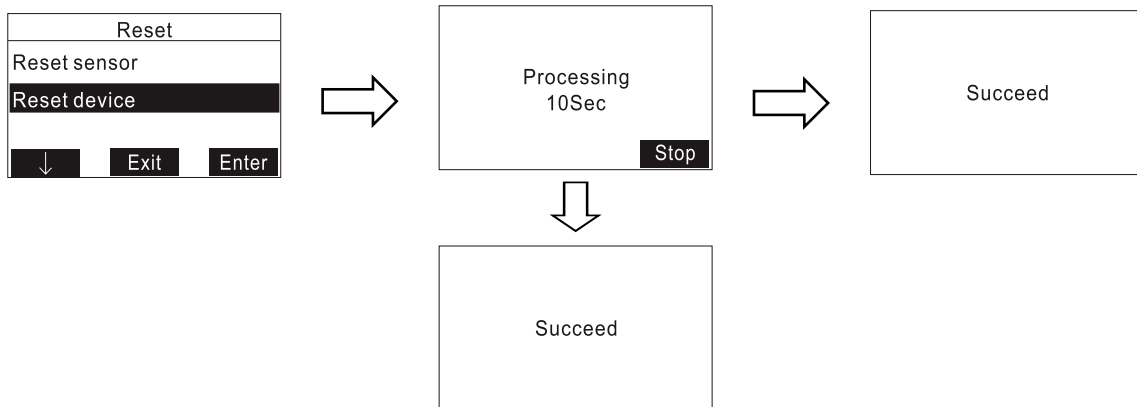

second countdown will be displayed. During the restoration of the instrument settings, press the [Y/+] key again to terminate the restore settings.

Note: The function of restoring factory settings is an irreversible operation. After setting, the parameters set by the user will be cleared and cannot be restored. Please use this function carefully.

14.9. Bluetooth function

The Bluetooth 5.0 of the instrument supports connection and communication with hand held devices of Android 4.3 and above or iPhone 4S and above. It follows the standard modbus protocol to realize the active acquisition and control of the

instrument by the host, and uses the extended command format to complete the handheld device to actively issue query instructions to obtain real-time concentration, Alarm function. The user can judge whether the instrument has enabled the Bluetooth function by checking the presence of the Bluetooth icon at the top of the detection interface.

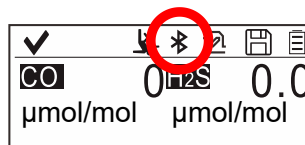
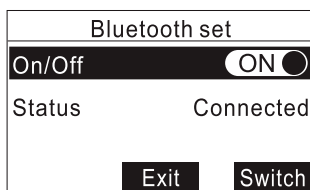

- Press [Y/+] to turn on or off the Bluetooth function.

Note: Bluetooth function is an optional function, instruments without Bluetooth function do not have this menu.

16、About

16.1 Monitor Information

Device information includes software Version, Site ID, User ID, date of Factory.

Monitor info	
Version:	V1.2.7
Site ID:	0001
User ID:	0001
Factory	2021-05-20
Exit	

16.2 Sensor information

Sensor information includes Gas type, Range, ADC value.

Gas	Range	ADC
CO	1000	0
H ₂ S	99.0	0
O ₂	30.0	0
EX	100	0
Exit		

16.3 Calibration record

The calibration record contains the date of the last calibration and the recommended date for the next calibration.

Calibration record	
Last calibration date	2020-05-20
Next calibration date	2020-08-20
Exit	

17、 Common faults and solutions

Fault	Possible cause of fault	Solution
phenomenon Unable to turn on	The voltage is too low	Please charge in time
	Crash	Please contact the dealer or manufacturer for repair
	Circuit failure	Please contact the dealer or manufacturer for repair
No response to detection	Circuit failure	Please contact the dealer or manufacturer for repair
gas The display is inaccurate	The sensor has expired	Please contact the dealer or manufacturer for repair
	Long-term uncalibrated	Please calibrate in time
The time display is wrong	The battery is completely exhausted	Charge it in time and reset the time.
	Strong electromagnetic interference	Reset time
Zero point calibration function is not available	Excessive sensor drift	Calibrate in time or replace the sensor
	For over-range use	Please contact the dealer or manufacturer for repair
When the instrument normally detects, the interface displays the full scale	Sensor failure	Please contact the dealer or manufacturer for repair
Self-check failed	The sensor cannot be found	1.Restart the instrument 2.Please contact the dealer or manufacturer for repair
	Memory read failure	Please contact the dealer or manufacturer for repair
	The pump does not run	1.Enter the menu and turn on the pump switch to see if it runs normally 2.If the pump is blocked or damaged, please contact the distributor or manufacturer

18、 Terms of Service

18.1 Warranty Commitment

The company promises that all detectors manufactured by the company will be calibrated with the relevant standard gas of specific concentration. After purchasing the company's products, users do not need to calibrate the target point of the detector by themselves, and the operation must be performed by professional and technical personnel. Under the guidance of All the gas detectors of this series purchased through our distributors will provide you with a 12-months warranty service from the date of purchase.

This commitment is limited to the mainframe since the purchase, excluding accessories. During the service period, if under normal use and maintenance conditions (non-human factors), the product itself has a component that has a fault, and our inspection is true, you will receive our free service for you.

18.2 Fault repair time

When your machine needs to be repaired, we will repair it for you and return it within 7 valid working days after receiving the machine you sent back. In case of special circumstances, if the repair cannot be completed within 7 effective working days, our staff will call you in advance to negotiate the repair date.

The aforementioned repair date does not include the return time.

18.3 Limited liability guarantee

After your product is repaired by our maintenance organization, it will continue to enjoy the promise of the original warranty period.

When you need warranty service, please present a valid warranty certificate, including a warranty card and purchase invoice or purchase contract.

When there is a situation listed in the warranty statement that is not within the scope of the warranty, you can choose paid repair services.

If the repair parts exceed the free warranty period, please pay a certain repair service fee. The standard of the repair service fee is provided by our maintenance organization.

We have the right not to provide warranty service if the product is damaged due to the following conditions:

- 1) Damage caused by man-made.
- 2) Damage caused by violation of operating regulations and requirements.
- 3) Damage caused by all natural disasters such as floods and fires.
- 4) Damage caused by harsh environment.
- 5) Repair, alter, modify or disassemble this product by unauthorized service personnel.

19、 Technical support and manufacturer

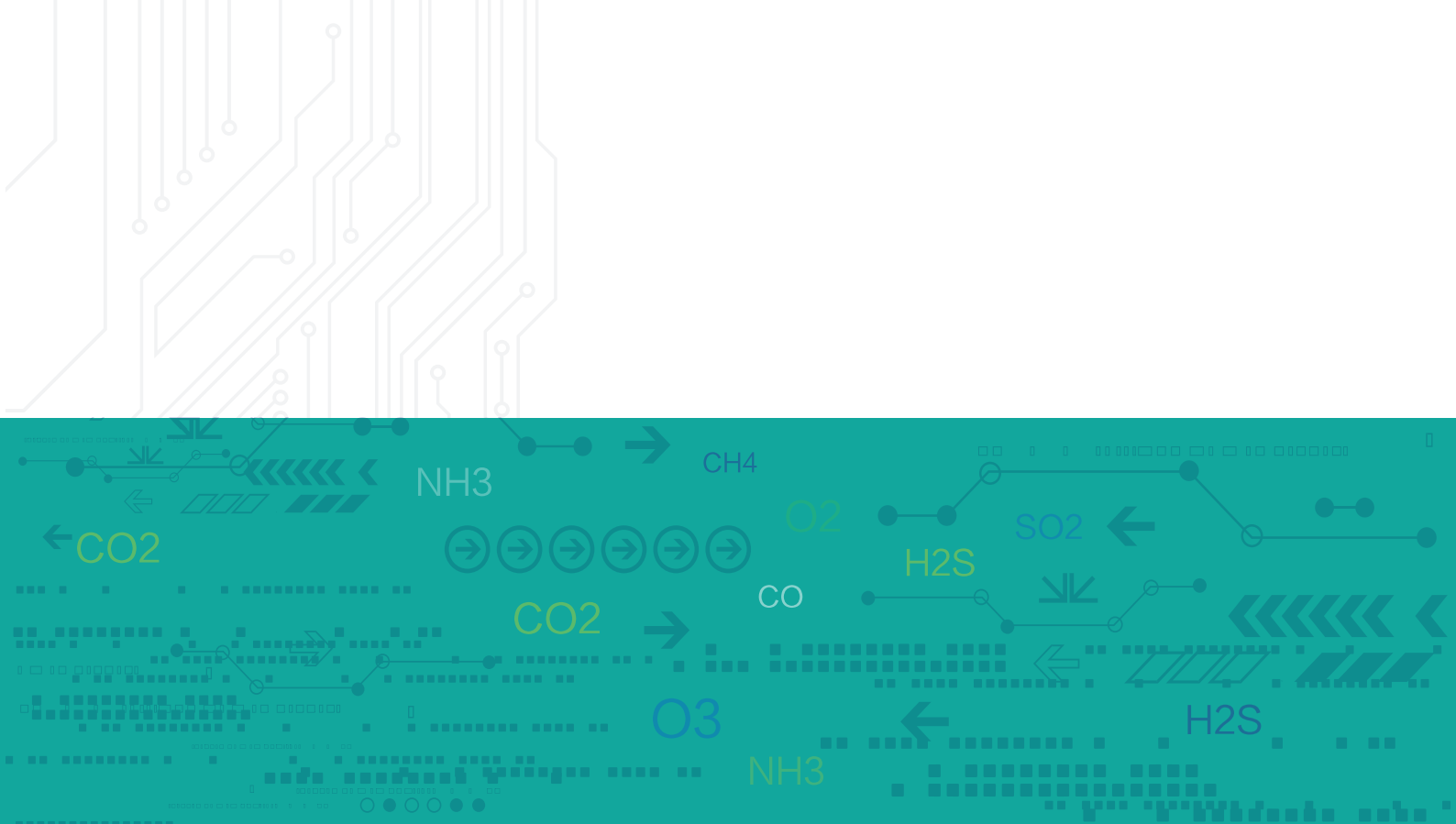

GD500
handheld multi gas detector

GD500

Handheld Multi Gas Detector

Product Overview

GD500 series gas detector is kind of mini size and high accuracy portable multi gas detector. Easy to operate, comprehensive functions, can measure 4 common gas hazards: carbon monoxide, hydrogen sulphide, flammable gases and oxygen depletion, other multi gases are available for customization. The detector is with back clip, protected by silicone case, suitable for different kinds of situations.

Specialized in Gas Detection For 16 Years

Product Advantages

- Employ original imported high-precision sensor.
- Four random gas sensors can be combined freely.
- LCD dot matrix display, support Chinese and English operation.
- The gas concentration unit PPM and mg/m3 can be shifted quickly.
- The battery and voltage can be checked by one press.
- One press to restore factory settings.
- Ultra-high buzzer alarm sound, alarm with sound, light and vibration at the same time.
- Can record 100 sets alarm data, alarm record can be checked on the device.
- Data storage function, can record 100 thousand set data, historical data can be viewed on the device (optional function). Rechargeable lithium polymer battery of large capacity, which ensure the device to work continuously for a long time. Strong and upscale alligator clip, convenient to take along during operation.
- Special engineering plastics housing of high intensity, strong and durable, exquisite and comfortable in touching.



GD500 handheld multi gas detector

Application



▲ Petrochemical & Chemical Industry



▲ Municipal Engineering & Utilities



▲ Agricultural & Environmental Protection



▲ Electronic



▲ Food & Pharmaceutical Industry



▲ Other Industries

Accessories & Configuration List

- A charging adapter
- Color Box warranty
- Card Instruction
- Qualification
- Certificate



Technical Specification

GD500

Sampling method	Diffusion
Detected gas	CO H2S O2 EX, etc . According to customers' requirements.
Detection principle	Electrochemistry, infrared ray, catalytic combustion, PID photo ionization (according to the target gas and sensor).
Measure range	The range is optional, according to the target gas and the sensor.
Resolution	According to sensor and measure range
Precision	According to sensor.
Unit	ppm、mg/m3, %VOL (ppm、mg/m3 can be shifted by one click, the concentration value will be auto converted by the system)
Display	Monochrome dot matrix 128*128 LCD graphic display.
Backlight	Time of backlight is settable, when alarm the backlight will be auto on.
Data recording	Storage capacity of over one hundred thousand sets. Interval time ranges from 10~3600 seconds are settable. (Optional function)
Alarm recording	can record 10000 set alarm record, the record can be checked on the device. (Optional function)
Language	Chinese/English
Alarm type	sound, light, vibration.
Battery	3.7V rechargeable lithium battery, with capacity of 2300mAh.
Working Time	14h continuously (common 4 gases). 200h(without LEL sensor)
Charger	travel charger with USB. Charging time: 4~6h
Explosion-proof grade	Explosion-proof grade: Exia II CT3
Protection grade	Protection grade: IP65
Working temperature	Working temperature: -20℃ ~ 50℃
Working humidity	Working humidity: 0-90%RH (Non-condensing, a filter dryer is needed in environment of humidity more than 90%RH)
Housing Material	Housing Material: ABS+ leather case
Dimension	Dimension: 131*83*35mm (length*width*height)
Weight	Weight: 240g

Normal gas types and paramaters (Other gases are not listed can be customized)

Detected gas	Measure Range	Optional ranges	Resolution	Response time
Flammable gas (EX)	0-100%LEL	0-100%VOL	0.1%LEL/0.1%VOL	≤10S
Oxygen (O2)	0-30%VOL	0-25%VOL	0.01%VOL/0.1%VOL	≤10S
Carbon monoxide (CO)	0-1000ppm	0-2000ppm	0.1ppm/1ppm	≤10S
Hydrogen sulfide (H2S)	0-100ppm	0-1000ppm	0.01ppm/0.1ppm	≤10S
Ammonia (NH3)	0-100ppm	0-200ppm	0.01ppm/0.1ppm	≤10S
Chlorine (CL2)	0-10ppm	0-100ppm	0.01ppm/0.1ppm	≤10S
Hydrogen Chloride (HCL)	0-20ppm	0-100ppm	0.01ppm/0.1ppm	≤10S
Nitric oxide (NO)	0-100ppm	0-250ppm	0.01ppm/0.1ppm	≤10S
Nitrogen dioxide (NO2)	0-20ppm	0-100ppm	0.01ppm/0.1ppm	≤10S
formaldehyde (CH2O)	0-10ppm	0-50ppm	0.01ppm/0.1ppm	≤10S
Ozone (O3)	0-10ppm	0-100ppm	0.01ppm/0.1ppm	≤10S
Carbon dioxide (CO2)	0-2000ppm	0-100%VOL	1ppm/0.01%VOL	≤10S

Project Cases



◀ GD500
Used in Large oil refinery and metallurgical plant, etc



▼ GD500
Applied in wastewater treatment, sewers, etc

▶ GD500
Used in laboratory, hospitals, pharmaceutical factory, etc

▼ GD500
Applied in dockyards, workshops, etc





More Application

- Furniture, Floor, Wallpaper, Coating, Gardening, Interior Decoration and Renovation, Dyestuff, Papermaking, Pharmacy, Health Care, Foodstuff, Antiseptic.
- Disinfection, Chemical Fertilizer, Resin, Adhesive, Pesticide, Raw Material, Sample, Technological Process, Livestock Farm, Refuse Processing Plant, Perm Place.
- Bio-pharmaceutical Plant, Green Household, Livestock Breeding, Green House Cultivating, Warehouse Logistics, Brewing And Fermentation, Agricultural Production.

User Manual-GD500

Thanks for purchasing our product. Please read the user manual carefully before using.

Keys Operation:

	<p>ON/OFF: long press for 3 seconds to turn on/off the device. In detection mode, short press to check battery power, and press again to go back to detection mode. In parameter settings, short press to confirm or save settings.</p>
	<p>UP: in detection mode, long press the UP button to enter into menu, and in parameter setting mode, short press this button to move to upper item.</p>
	<p>PPM and mg/m³. In parameter setting mode, short press it to go back to next item. DOWN: in detection mode, long press to shift the gas concentration unit quickly, but it is restricted to</p>

(Note: The long press function only works in detection interface. When you change or reset any data, please remember to click "ON/OFF" button to confirm and save the settings)

Power On

Press the "ON/OFF" for three seconds, the detector will be turned on. The screen displays the following interface successively: Brand and Logo, main parameter interface, initialing countdown. The countdown would be 30~60 seconds, which is to make sure that the sensors are fully activated. After 30 seconds the device enter normal detection mode.

Zero Calibration

Zero calibration must be done in clean air. Zero calibration is needed when there is zero shift happens.

Put the detector in clean air for 3-5 minutes, under the detection mode, press the "UP" and "DOWN" buttons at the same time for three seconds, the data of all channels will reset to zero automatically.

Note: Zero calibration of oxygen detector, nitrogen detector and carbon dioxide detector (target gases are component of the air), the data will be defaults to 20.9%VOL (O₂), 79.1%VOL (N₂), 400ppm (CO₂). Do not do the zero calibration in not clean air or when there is no zero shift happens.

Process of Over-range incorrect operation

Users should avoid using gases which exceed the measure range to impact the sensor, because it will affect the lifespan and sensitivity of the sensor, even, "poison" the sensor. If there is any over-range incorrect operation makes the detector displaying an concentration at a large reading, the remedy is to take the device out of the environment immediately and put it in clean air for over half an hour, and then observe the reading, if it keeps going down, then wait until the reading back to zero before powering it off, and do the zero point calibration next time before using it. If the reading maintained at full scale, user should send the device back to manufacturer or agent for repair or replacing the sensor.



- ① — Alarm light
- ② — Silicon rubber case
- ③ — LCD
- ④ — USB charging port
- ⑤ — UP
- ⑥ — DOWN
- ⑦ — ON/OFF
- ⑧ — Sensor air chamber

Note

*If detector is used for the gas cylinder detection, considering the high pressure in the cylinder, please use a pressure regulator, and keep it as the below data:

Flow rate: 800mL~1L/minute

Pressure: 0.1MPa or 1Bar

*Working temperature: -20~50 degree C

*Working humidity: 0-95%RH, no condensing

*Please put the detector in clean air for about 5 minutes and waiting for the data falling down to normal before turning it off after measurement.

Operation Interface

When the detector is turned on completely, the device will enter the detecting mode. The detected gases will be showed on the screen (for example: O₂, CO, H₂S, EX). Time and battery power will be showed at the top right. If measured 4 gases, the time and battery power information can be checked by short press the ON/OFF button.

Alarm Status

When the detected gas concentration is higher than the low alarm value, the low alarm is auto on, the relative gas value will be highlighted, and the alarm sound will be on, blue light will be flickered.

When the detected gas concentration is high than the high alarm value, the high alarm is auto on, the relative gas value will be highlighted, and the alarm sound will be on, red light will be flickered.

When there is low alarm and high alarm at the same time, both relative gas values will be highlighted, and high alarm will take the priority.

Low Battery Alarm

When the battery is low, there will be sound, light low battery alarm. There will be sound and light every 5 seconds to remind the user to charge the device in time. When the battery is used up, the device will be turned off automatically.

Alarm Setting

In detection model, long press “UP” button to enter the menu, choose the “Alarm point”, and start to set the alarm value.

There are four options under the alarm setting mode. The first option is the “channel”, there will be 4 channels for 4 in 1 multi gas detector.

Channel choose

press “ON/OFF” button, the cursor will be at the channel number, then press the “UP” and “DOWN” button to choose the channel, press the “ON/OFF” button to confirm.

Alarm setting

The second option is the low alarm value, and the third option is the high alarm value. Choose the option that you want to change, then press “ON/OFF” to confirm, then press the “UP” and “DOWN” to increase or decrease the value, press the “ON/OFF” to move cursor. After the setting is done, press “ON/OFF” button to save the settings.

Settings

In detection model, long press “UP” button to enter the menu, choose the “INST Setup”, and start to set the detector.

There are three options: Language, gray level, LCD backlight.

Language: Chinese and English are available.

Calibration

Note: Calibration needs to be done by professionals and with necessary accessories and standard gas. Password is needed. (If you need password, please contact the manufacturer to get it)

In detection mode, long press the “UP” button, choose the CALIBRATION. There are five options in the calibration interface:

1. **Channel option:** you need to choose the right channel/gas type before calibration, there will be 4 channels for the 4 gases multi gas detector.
2. **Zero calibration option:** put the detector in clean air for 3-5 min, then press “ON/OFF” button, wait for the value become stable, press “ON/OFF” again, the zero calibration is finished. You can also do the zero calibration in the detection mode, press the “UP” and “DOWN” buttons for three seconds, the data of all channels will reset to zero automatically.
3. **Target point calibration:** Prepare the standard gas before starting the target point calibration. Choose standard gas, press ON/OFF button to enter. There will show “please input standard gas” at the top of the LCD, and at the bottom there are “gas type”, calibrate value, “VA” (current concentration), “AD”, and “ESC or SET”. Change the target concentration to the standard gas concentration by press “UP” and “DOWN”, after the value is stable, press the “ON/OFF”, to finish the calibration.

The detailed process is as below:

1. Connect the detector with standard gas cylinder by tube.
2. Enter the standard gas calibration interface.
3. Change the target point value to the standard gas value.
4. Release the standard gas to the detector in a flow rate of 400mL/min. The value of “current concentration” will become larger gradually, and become stable after about 30 seconds.
5. When the value of VA and AD is stable, the value of “current concentration” will be same with or almost same with the “target point value”. Press the “UP/DOWN” button to change the “SET” to “CONFIRM”, and press the “ON/OFF” button, the calibration is finished.
6. Cut off the standard gas supply.

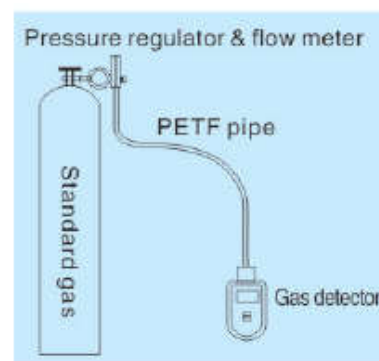

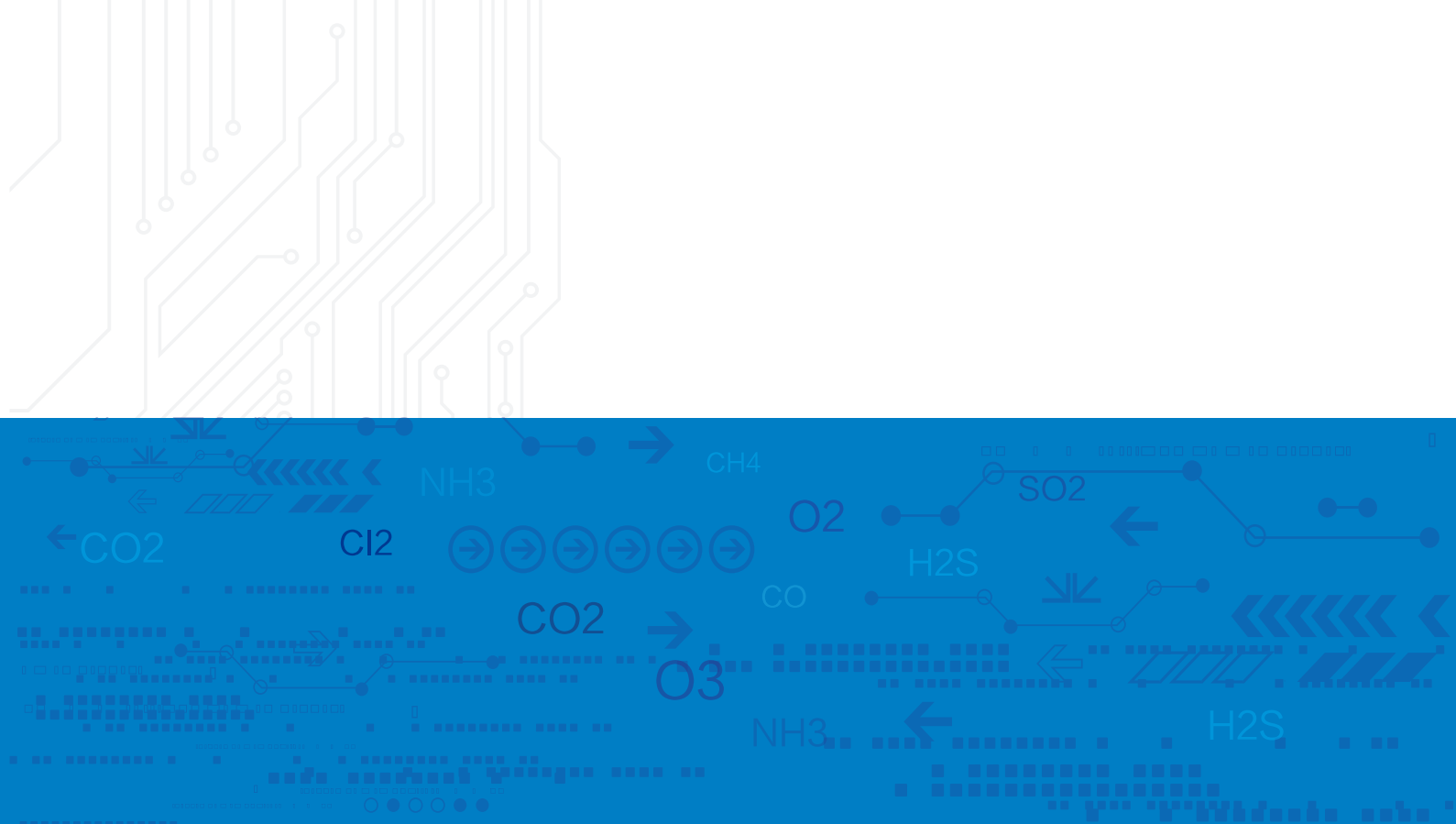

GD600

Multi Gas Analyzers

Product Overview

GD600 series gas analyzer is a data collector which can quickly acquire and analyze gas concentration components in scientific research, university and complex working environment.

GD600 gas analyzer can detect up to 18 gases simultaneously. It can integrate electrochemistry, catalysis, thermal conductivity, infrared, light ion, ultraviolet and other detection principles, focus-ing on the accuracy of gas detection and user experience.

GD600
Gas Analyzers Can Detect Up
18 Gases Simultaneously.

Specialized in Gas Detection For 16 Years

Product Advantages

Accurate and Reliable

- Using world top brand sensors, the test results are more reliable and can be certified by third party authorities.
- Multiple industrial pump gas sampling, ten grades of pumping flow rate for selection. Gas detection flow can be customized according to different testing environments.
- Each module is equipped with multi-layer filtering device, which can filter oil, water, dust and other impurities efficiently.

Multi-display Mode

- Single curve, multi-curve, data and other gas concentration display mode are switchable.
- Various gas concentration units can be shifted freely.

Comprehensive Functions

- Modular internal structure, supporting 1-18 gas detection requirements.
- Three pumps to control three different modules.
- Analyzer can be equipped with internal printer Bluetooth printer, to realize the mobile print function(Optional).
- High temperature, high humidity environment measurement(Optional).



Multi Gas Analyzers

Data Logging

- Large capacity quick storage function, storage space can be customized
- An independent SD memory card, historical tested data can be viewed and deleted

Mobile Recharging and Long Operation Time

- High capacity of lithium polymer rechargeable battery, super long service life and standby time.
- Mini-USB charging interface design with common data cable and mobile power can be charged anytime, anywhere.

High Quality Material

- 3.5-inch hd LCD screen with resolution 320* 480, beautiful and useful menu interface.
- Selected aviation wear-resisting material, suitable for various kind of industry environment.

Application



▲ Petrochemical & Chemical Industry



▲ Municipal Engineering & Utilities



▲ Agricultural & Environmental Protection



▲ Electronic



▲ Food & Pharmaceutical Industry



▲ Other Industries

Accessories & Configuration List

Standard Accessories

- Instruction
- Qualification certificate
- warranty card
- a Micro-USB cable
- a water,vapour,smoke filter
- an intake sampling rod
- 600mm tube
- Non - toxic, tasteless, explosion-proof, waterproof, heat - resistant, high - temperature resistant, corrosion resistant suitcase (1 set)



Optional Accessories

- Printer (built-in bluetooth printer)
- High Temperature Probe: 600C, 1200C.
Imported from Germany

Technical Specification

GD600

Size	(H x W x D) 260*230*120mm		
Weight	3700g		
Battery	Large capacity rechargeable lithium battery,5400mAh/11.1V (internal printer type) or 10000mAh/3.7V (external printer type) working hours are more than 32h with single gas and 24h with six gases together		
Precision	≤±2%F.S (Higher precision can be customized)		
Temperature and humidity measurement Temperature:	-20-50℃, Resolution: 0.1℃; Humidity: 0-95%RH, Resolution: 1%RH		
Pump flow rate	500 cc/Min.		
Humidity	0~95%RH(no condensation)(optional filter device is available if high humidity)		
Temperature	-20℃~+50℃ .Optional gas sampling gun,can detect up to 1200 degrees gas concentration		
Screen	3.5-inch hd LCD screen with resolution 320* 480		
Degree of protection	IP66	Explosion-proof	II 2G Ex ia IIC T4 Ga IP66
Pressure measurement	1 bar	Warranty	Free repair 12 months,Lifelong maintenance

Ordering Information

Detecting gas	O2, N2, CO2, EX, VOC, PH3, etc. According to customers' requirements.
Sensors	Electrochemistry, infrared ray, catalytic combustion, PID photo ionization (according to the target gas and sensor).
Measure range	The range is optional, according to the target gas and the sensor.
Resolution	According to sensor and measure range
Display	Formula, gas concentration data, measurement trend curve, gas curve, battery, time, temperature, humidity, pump condition, wireless status, printer status, screen shot status

Key Features

Alarm	Buzzer, red LED and alarm status on the display, fault alarm, pump abnormal alarm, low battery alarm
Data storage	Independent SD memory card, Max.32G, measurement data can be record automatically, customizable record time interval.
Data transmission	USB interface data transmission with USB stick, can download storage, analyze and print data
Print function (Optional)	Optional with internal bluetooth printer
Print content (Optional)	EXCEL
Charger	Standard Mini-USB charging port. With 12.8V/1.5A special charger (built-in printer) or 5V/2A universal charger
Language	English
Network frequency	2.4G high frequency.
wireless transmission distance	Bluetooth is less than 10m(In development)

Project Cases



◀ GD600
Application in university laboratory, research institute, etc.

▼ GD600
Used in Large oil refinery and metallurgical plant, etc.



▶ GD600
Applied in Inspection and quarantine bureau, hospital, etc.

▼ GD600
Used in mines, tunnel engineering site



More Application

- Furniture, Floor, Wallpaper, Coating, Gardening, Interior Decoration and Renovation, Dyestuff, Papermaking, Pharmacy, Health Care, Foodstuff, Antiseptic.
- Disinfection, Chemical Fertilizer, Resin, Adhesive, Pesticide, Raw Material, Sample, Technological Process, Livestock Farm, Refuse Processing Plant, Perm Place.
- Bio-pharmaceutical Plant, Green Household, Livestock Breeding, Green House Cultivating, Warehouse Logistics, Brewing And Fermentation, Agricultural Production.



GD700

Industrial Fixed Detector

Product overview

GD700 series is a built-in pump-suction multi gas detector, which can detect 1-6 kinds of gases at the same time, continuously monitor the concentration of various gases online for 24 hours. Use a 2.4-inch high-definition color screen to display the on-site concentration in real time, and output 4-20mA, RS485 Standard signal, transmit data remotely. GD700 series is with advanced circuit design, mature kernel algorithm processing, obtained a number of software work patents and appearance patents. GD700 series can detect gas concentration in pipelines, confined spaces, and atmospheric environments, and can also detect gas leakage. The instrument has a built-in constant flow and large suction pump, which is accurate in detection, and has a faster and more sensitive response than diffusion models. When the target detected gas is lighter than air, no need to install at high place, which can get the detection results quickly and safely.



GD700

The world's first built-in industrial fixed detector

Specialized in Gas Detection For 16 Years



Product Advantages

With internal suction pump, fast response

" With a built-in constant flow and large suction pump, which is accurate in detection, and has a faster and more sensitive response than diffusion models.

Can detect multiple gases, multiple display

Up to 6 kinds of gases can be detected at the same time. In complex and multi-gas environments, multiple installations can be reduced, saving time and effort.

2.4-inch industrial-grade high-definition color screen with a resolution of 320*240 and a wide viewing angle of 120 degrees. Supports ppm, mg/m³, μmol/mol display units. Units can be switched arbitrarily, and the concentration value is automatically converted by the device.

Can support wireless transmission(optional)

With optional wireless module, data can be uploaded to the cloud platform, environmental protection bureau or other platforms, providing SMS reminder function, the transmission signal is not limited by distance, and can be viewed in real time on mobile phones and computers.

With strong anti-interference, data is reliable

Can resist strong magnetic interference. Data is guaranteed to be stable and reliable in areas with strong magnetic products or densely populated areas such as tunnels, mines and confined spaces.

Powerful function, multiple transmission signals and output

With full software automatic verification function and zero calibration function, making gas monitoring more accurate and more reliable.

Standard 4-20mA current signal, RS485 digital signal, 1 set of relay signal output, optional 2 sets of relay signal.

Standard infrared remote control, which can remotely control the detector and modify the detector settings.

With sound and light alarm function, there is sound and light alarm when reaching the alarm point.

For the harsh environment with high temperature, high humidity and high dust, a pretreatment system can be selected to cool down, dehumidify and remove dust to protect the service life of the detector.



GD700
industrial fixed detector

Application



▲ Petrochemical & Chemical Industry



▲ Municipal Engineering & Utilities



▲ Agricultural & Environmental Protection



▲ Electronic



▲ Food & Pharmaceutical Industry



▲ Other Industries

Accessories & Configuration list

Standard accessories

- 1 piece of gas detector
- Infrared Ray controller
- Instruction manual
- Qualification certificate
- Warranty card

Optional accessories

- Dry filter device
- High temperature probe
- Pretreatment system Control
- Panel
- Power Adapter
- Switching power supply, etc.

GD700 industrial fixed detector

Infrared ray controller



Technical Specifications

GD700

Detected gas:	Oxygen, carbon dioxide, combustible gas, TVOC, hydrogen cyanide, arsine and other toxic and harmful gases
Detection principle:	Electrochemical principle, infrared principle, catalytic combustion principle, PID photoion principle (depending on the specific gas measured and the selected sensor)
Measure range:	Wide range optional (depending on the specific gas measured and the selected sensor may be)
Resolution:	Related to the selected sensor and range
Accuracy:	≤±3%F.S. (higher precision can be customized)
Response time:	≤30 seconds (T90)
Pump flow rate:	0.35-0.5 L/Min
Display:	2.4-inch color display, resolution 320*240
Display content:	gas molecular formula, concentration, unit, pump status, etc.
Concentration unit:	ppm, mg/m ³ , μmol/mol, etc. can be switched and displayed with one key, and the concentration value is automatically converted by the system
Alarm mode:	buzzer, alarm status prompt on the display screen, high and low alarm values can be set by customer
Signal output:	4-20mA, RS485, 1 set of relay output; 1-5VDC(optional), 2 sets of relay output(optional)
Communication and data download:	With PC software, history data can be downloaded, stored, printed, and analyzed in computer (optional)
Wireless output(optional):	optional wireless module, upload data to cloud platform or environmental protection bureau, transmission signal is not limited by distance; SMS reminder function (optional)
Network frequency:	2.4G high frequency
Installation method:	wall-mounted, pipeline, flow-through (optional)
Power supply:	12-24V DC
Language:	Chinese/ English (More languages can be customized)
Humidity:	0~95%RH (non-condensing) (if the humidity is too high, a filter device can be selected)
Temperature:	-20℃~+50℃ (high temperature probe can be selected if the temperature is too high)
Explosion proof grade:	Ex d IIC T6 Gb
Protection Level:	IP65
Weight:	3.4kg (3.8kg with alarm light)

Project Cases



- ◀ GD700
Used in Large oil refinery oil refinery and metallurgical plant, etc
- ▼ GD700
Applied in sewage disposal plant, storage logistics and warehouse



- ▶ GD700
Application in mines, Production workshop, site, etc
- ▼ GD700
Used in Inspection and quarantine bureau, hospital, etc.



More Application

Furniture, Floor, Wallpaper, Coating, Gardening, Interior Decoration and Renovation, Dyestuff, Papermaking, Pharmacy, Health Care, Foodstuff, Antiseptic. Disinfection, Chemical Fertilizer, Resin, Adhesive, Pesticide, Raw Material, Sample, Technological Process, Livestock Farm, Refuse Processing Plant, Perm Place. Bio-pharmaceutical Plant, Green Household, Livestock Breeding, Green House Cultivating, Warehouse Logistics, Brewing And Fermentation, Agricultural Production.